

Update on the genetic characterization of West Coast populations
of *Halyomorpha halys*
and adventive populations of its egg parasitoid *Trissolcus japonicus*

Marie Claude BON and Vincent LESIEUR

Corresponding author: mcbon@ars-ebcl.org



Brown Marmorated Stink Bug (BMSB) BioControl Identification Workshop
BMSB Integrated Pest Management (IPM) Working Group Meeting



Update on the genetic characterization of West Coast populations
of *Halyomorpha halys*
and adventive populations of its egg parasitoid *Trissolcus japonicus*

Active collaboration



- Elijah Talamas
- Matt Buffington
- Kim Hoelmer
- Christine Dieckhoff
- Kathleen Tatman

AND many others...

Update on the genetic characterization of West Coast populations
of *Halyomorpha halys*
and adventive populations of its egg parasitoid *Trissolcus japonicus*

- Phylogeography of *Halyomorpha halys* in the U.S.
- Genetic diversity of *Trissolcus japonicus*
- Phylogeny of the Asian *Trissolcus*

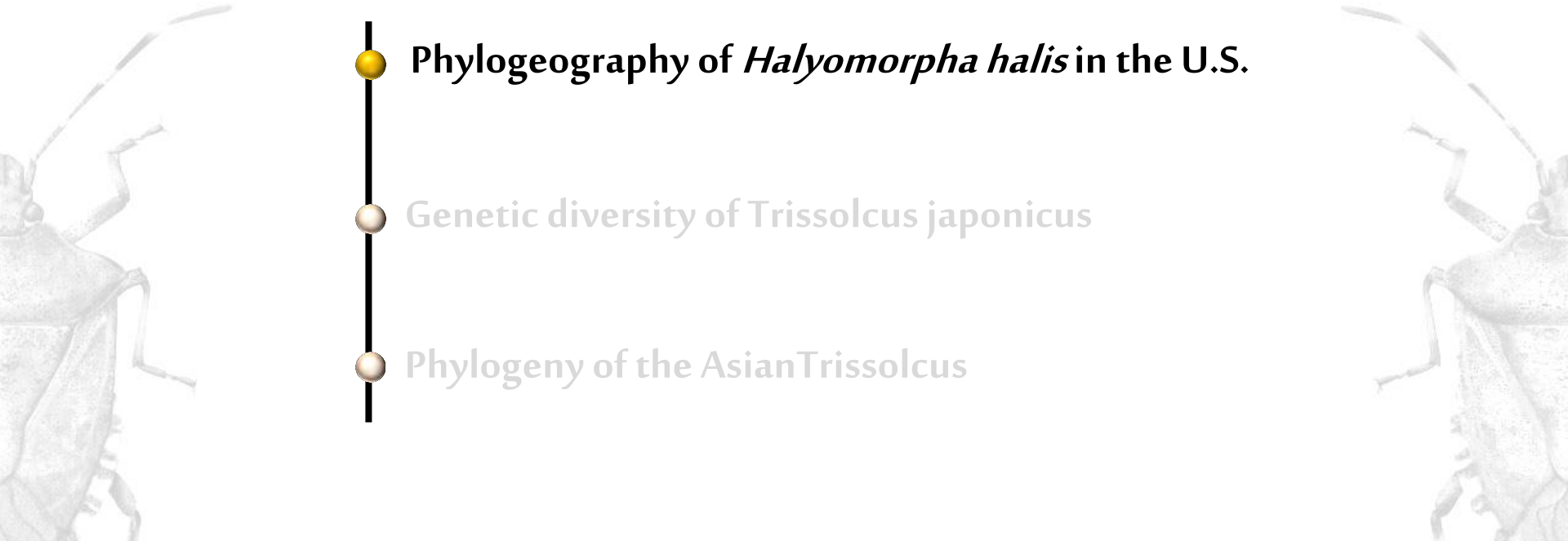

Update on the genetic characterization of West Coast populations
of *Halyomorpha halys*
and adventive populations of its egg parasitoid *Trissolcus japonicus*

- 
- Phylogeography of *Halyomorpha halys* in the U.S.
 - Genetic diversity of *Trissolcus japonicus*
 - Phylogeny of the Asian *Trissolcus*

What do we know so far?



What do we know so far?

Phylogeography of BMSB in Eastern America was already depicted by Xu et al. (2013)

Biol Invasions
DOI 10.1007/s10530-013-0510-3

ORIGINAL PAPER

Tracing the origin of US brown marmorated stink bugs,
Halyomorpha halys

Jiawu Xu · Dina M. Fonseca · George C. Hamilton ·
Kim A. Hoelmer · Anne L. Nielsen



What do we know so far?

Phylogeography of BMSB in Eastern America was already depicted by Xu et al. (2013)

Biol Invasions
DOI 10.1007/s10530-013-0510-3

ORIGINAL PAPER

Tracing the origin of US brown marmorated stink bugs, *Halyomorpha halys*

Jiawu Xu · Dina M. Fonseca · George C. Hamilton ·
Kim A. Hoelmer · Anne L. Nielsen

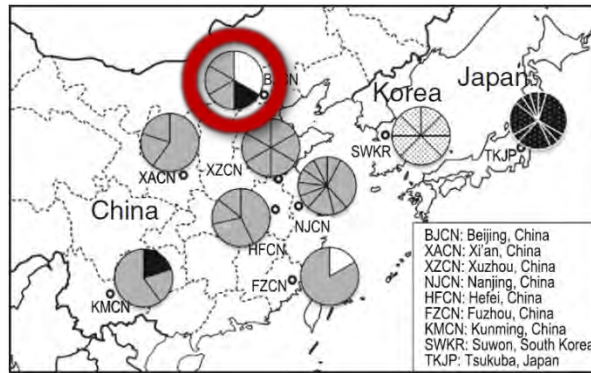

- A single introduction of small propagules size matches the invasion history in Eastern US
- Beijing area in China being the likely source of introduction

What do we know so far?

Phylogeography of BMSB in Eastern America was already depicted by Xu et al. (2013)

Biol Invasions
DOI 10.1007/s10530-013-0510-3

ORIGINAL PAPER

Tracing the origin of US brown marmorated stink bugs,
Halyomorpha halys

Jiawu Xu · Dina M. Fonseca · George C. Hamilton ·
Kim A. Hoelmer · Anne L. Nielsen

J Pest Sci (2014) 87:17–28
DOI 10.1007/s10340-013-0529-3

ORIGINAL PAPER

Occurrence, genetic diversity, and potential pathways of entry
of *Halyomorpha halys* in newly invaded areas of Canada
and Switzerland

T. D. Garipey · T. Haye · H. Fraser ·
J. Zhang

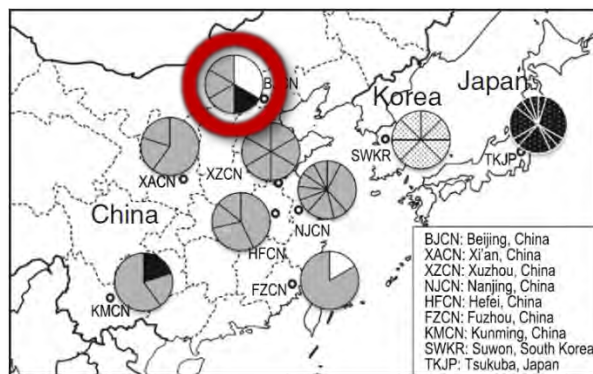

- A single introduction of small propagules size matches the invasion history in Eastern US
- Beijing area in China being the likely source of introduction
- Similar scenario Garipey et al (2014)
 - US populations acted as bridgeheads for Canadian populations

What about Western US?



What about Western US?



Phylogeographic approach

Same methods as Xu et al. (2013)



What about Western US?



Phylogeographic approach

Same methods as Xu et al. (2013)



3 mtDNA markers

- COII
- 12S rRNA
- 12S CR



What about Western US?



Phylogeographic approach

Same methods as Xu et al. (2013)



3 mtDNA markers

- COII
- 12S rRNA
- 12S CR

Sampling

- 119 specimens sampled
- 18 sampling locations
 - Oregon, Washington and California



Genetic diversity measures of BMSB

Geographic area	<i>n</i>	Number of haplotypes	Unique haplotype	Haplotype diversity	Nucleotide diversity
Western US (CA, OR, WA)	119	6	1	0.72	0.00168
Eastern US	55	2	0	0 - 0.67	0 – 0.0006
China	18	26 (2-5 per location)	24	0.81-1	0.0011- 0.0038
Korea (1 site)	8	7	7	0.96	0.0023
Japan (1 site)	21	10	10	0.87	0.0027

Genetic diversity measures of BMSB

Geographic area	<i>n</i>	Number of haplotypes	Unique haplotype	Haplotype diversity	Nucleotide diversity
Western US (CA, OR, WA)	119	6	1	0.72	0.00168
Eastern US	55	2	0	0 - 0.67	0 – 0.0006
China	18	26 (2-5 per location)	24	0.81-1	0.0011- 0.0038
Korea (1 site)	8	7	7	0.96	0.0023
Japan (1 site)	21	10	10	0.87	0.0027

- High genetic diversity in the native range

Genetic diversity measures of BMSB

Geographic area	<i>n</i>	Number of haplotypes	Unique haplotype	Haplotype diversity	Nucleotide diversity
Western US (CA, OR, WA)	119	6	1	0.72	0.00168
Eastern US	55	2	0	0 - 0.67	0 – 0.0006
China	18	26 (2-5 per location)	24	0.81-1	0.0011- 0.0038
Korea (1 site)	8	7	7	0.96	0.0023
Japan (1 site)	21	10	10	0.87	0.0027

- High genetic diversity in the native range

- Significantly lower in eastern US

Genetic diversity measures of BMSB

Geographic area	<i>n</i>	Number of haplotypes	Unique haplotype	Haplotype diversity	Nucleotide diversity
Western US (CA, OR, WA)	119	6	1	0.72	0.00168
Eastern US	55	2	0	0 - 0.67	0 – 0.0006
China	18	26 (2-5 per location)	24	0.81-1	0.0011- 0.0038
Korea (1 site)	8	7	7	0.96	0.0023
Japan (1 site)	21	10	10	0.87	0.0027

- High genetic diversity in the native range
 - Higher diversity in western US
 - Significantly lower in eastern US

California

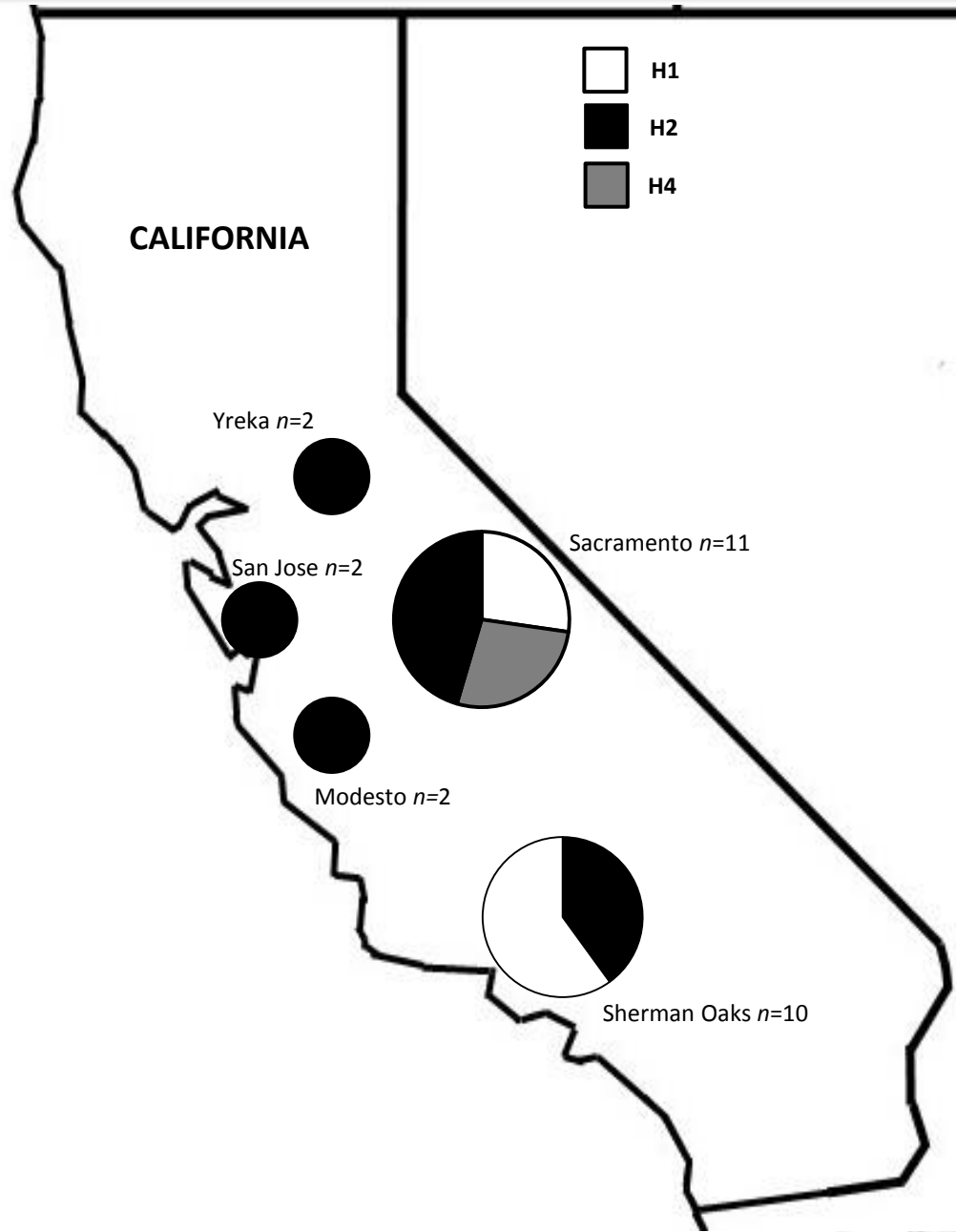

California

- 3 mt DNA haplotypes (combined dataset) recovered from 31 specimens
- Prevalence of H1 and H2 (similarly to the pattern observed in East Coast)

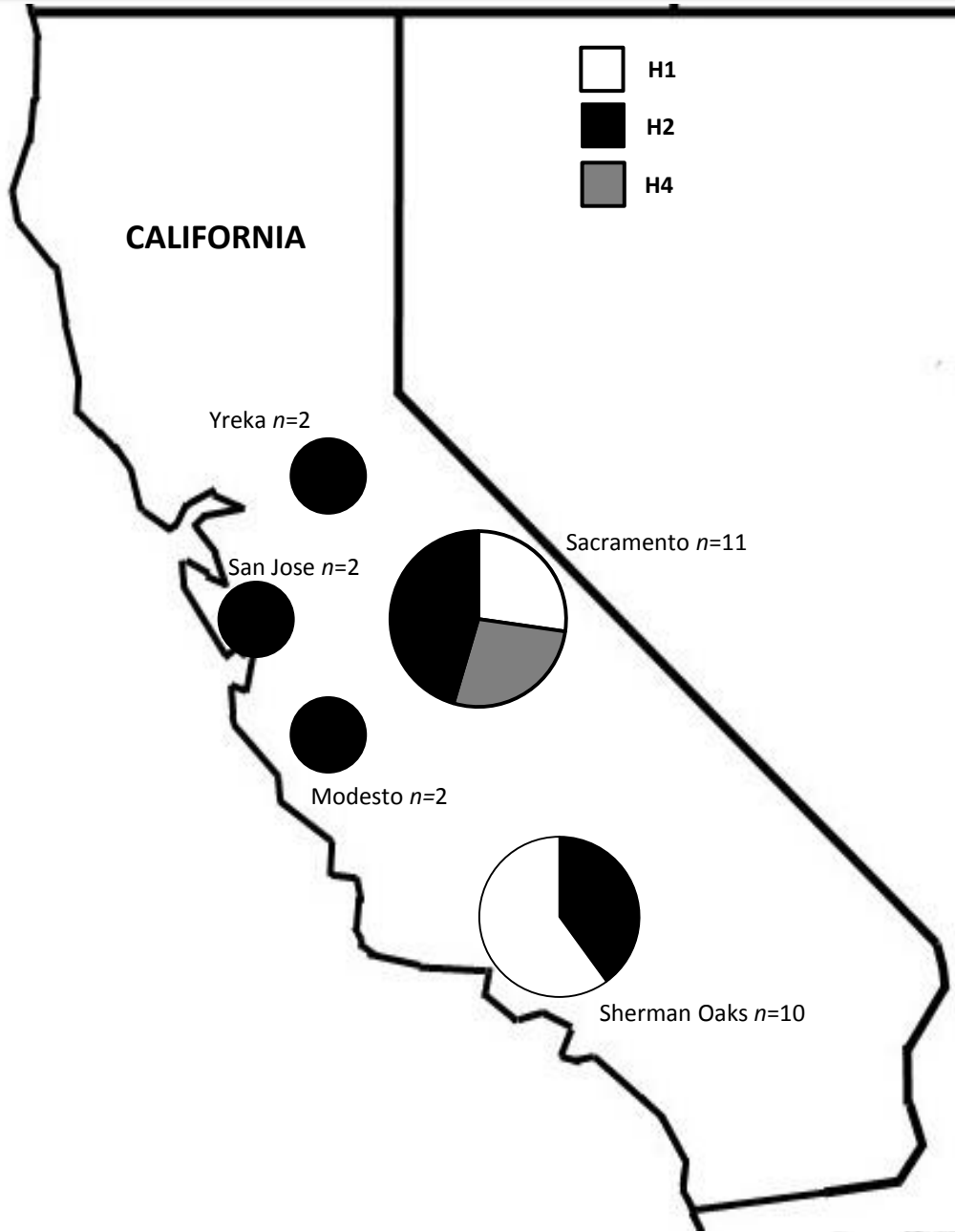

California

- 3 mt DNA haplotypes (combined dataset) recovered from 31 specimens
- Prevalence of H1 and H2 (similarly to the pattern observed in East Coast)



**Beijing area in China:
the likely source region for California**

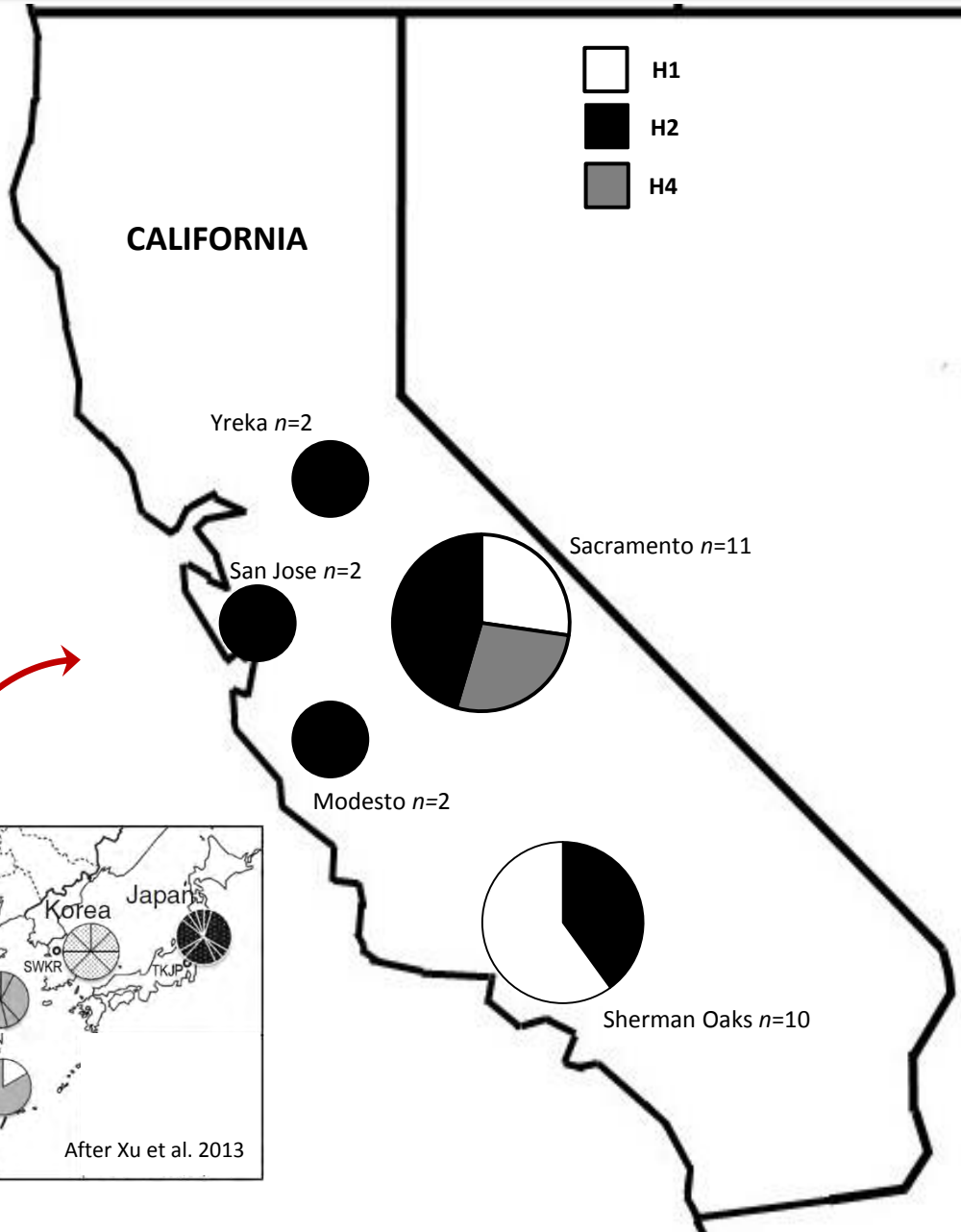
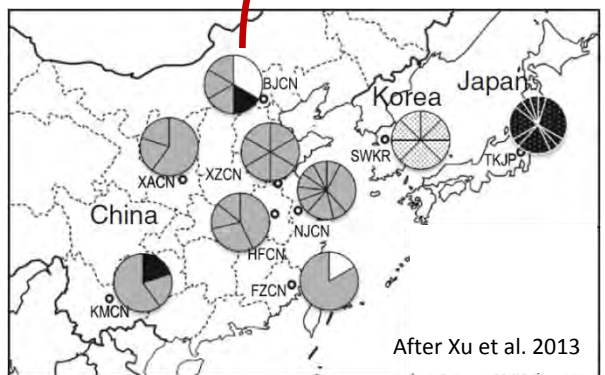

Washington and Oregon



Washington and Oregon

- 6 haplotypes recovered from 88 specimens

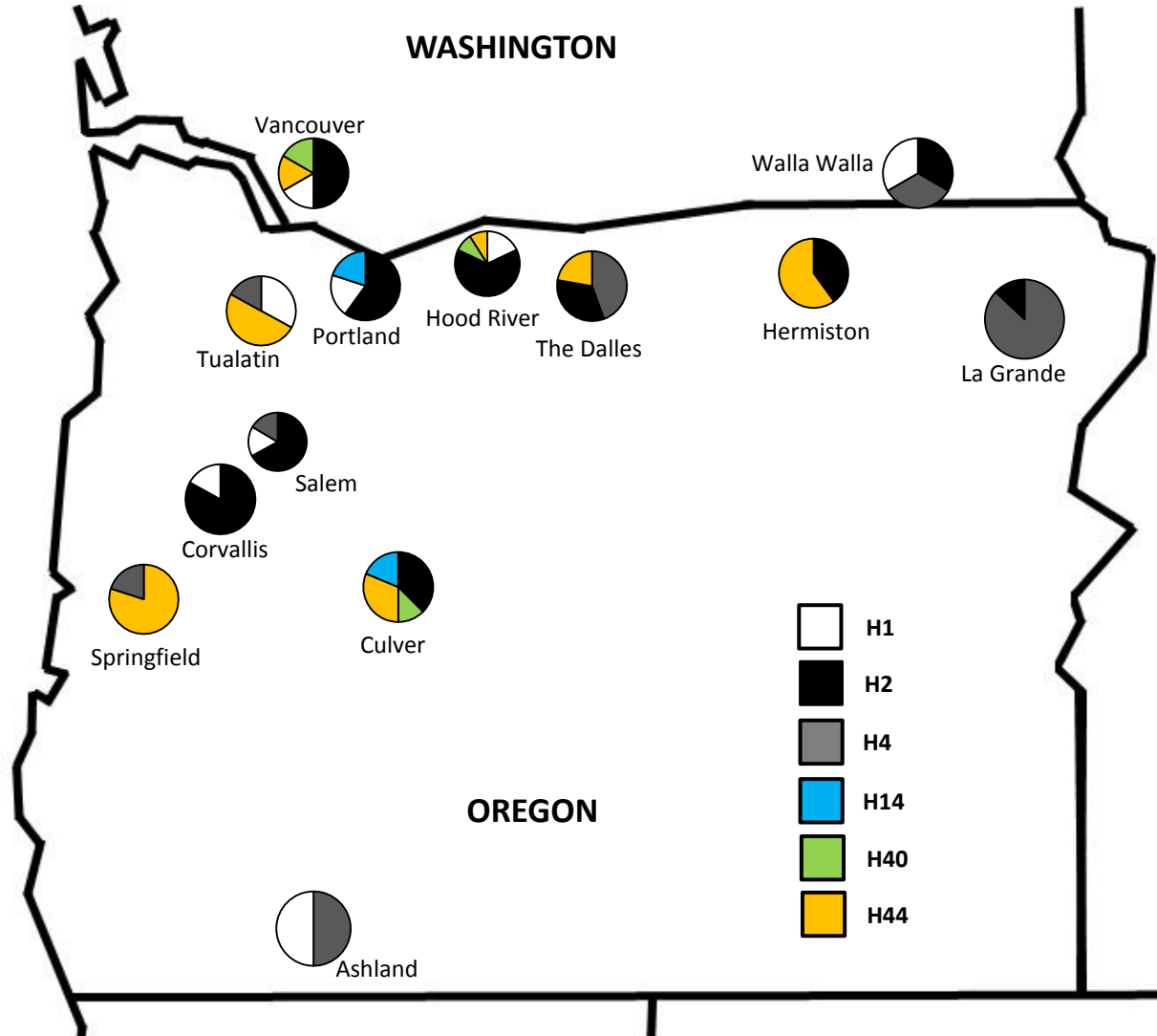

Washington and Oregon

● 6 haplotypes recovered from 88 specimens

● Prevalence of H2 (39%) and to a less extent H44 (21%)



H44 is evidenced for the first time

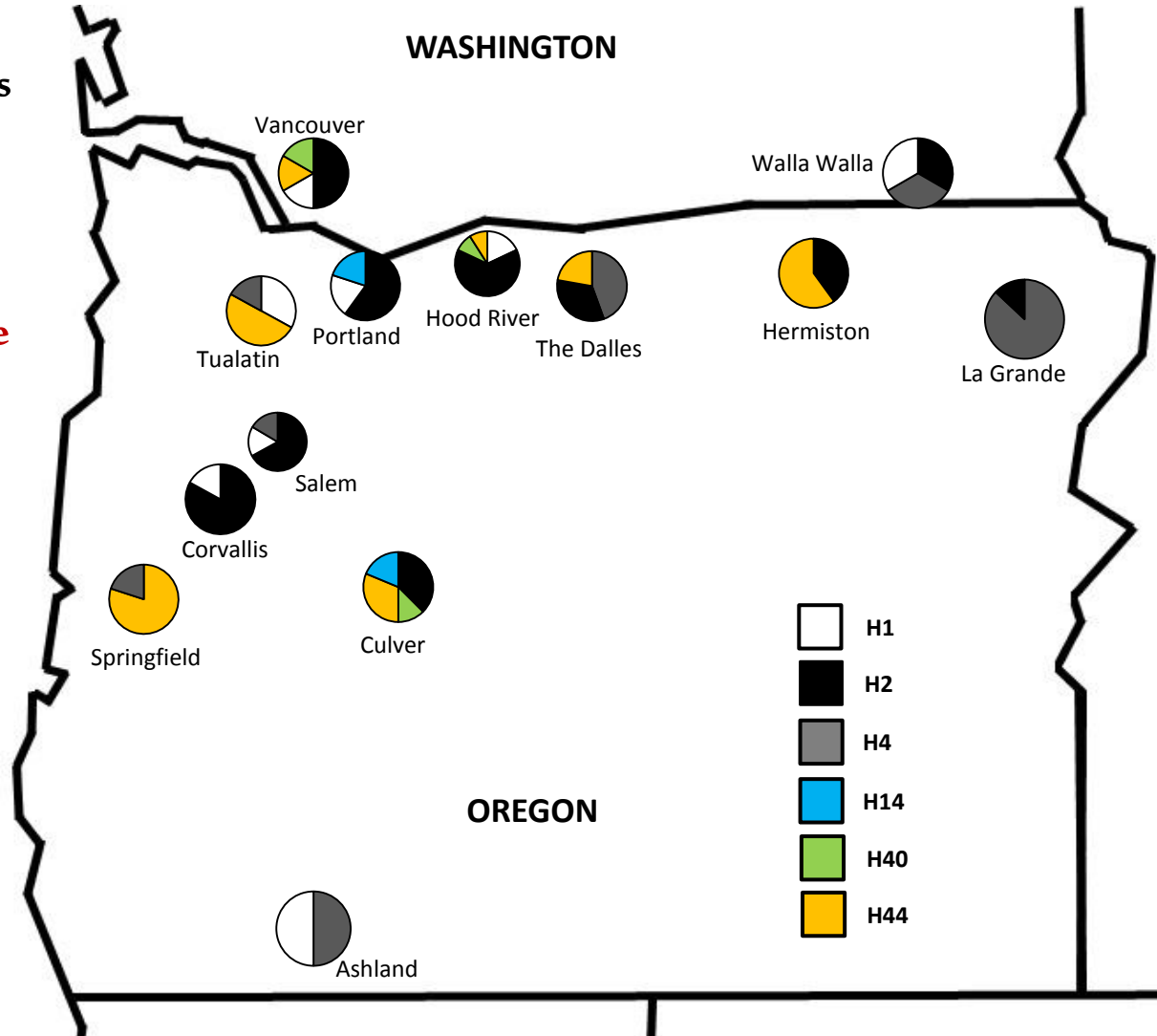

Washington and Oregon

- 6 haplotypes recovered from 88 specimens
- Prevalence of H2 (39%) and to a less extent H44 (21%)



H44 is evidenced for the first time

H1, H2, H4 and H14

Beijing and Nanjing areas in China:
the likely source regions for WA and OR

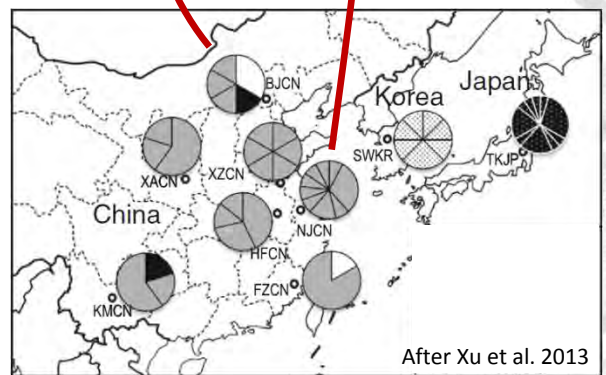
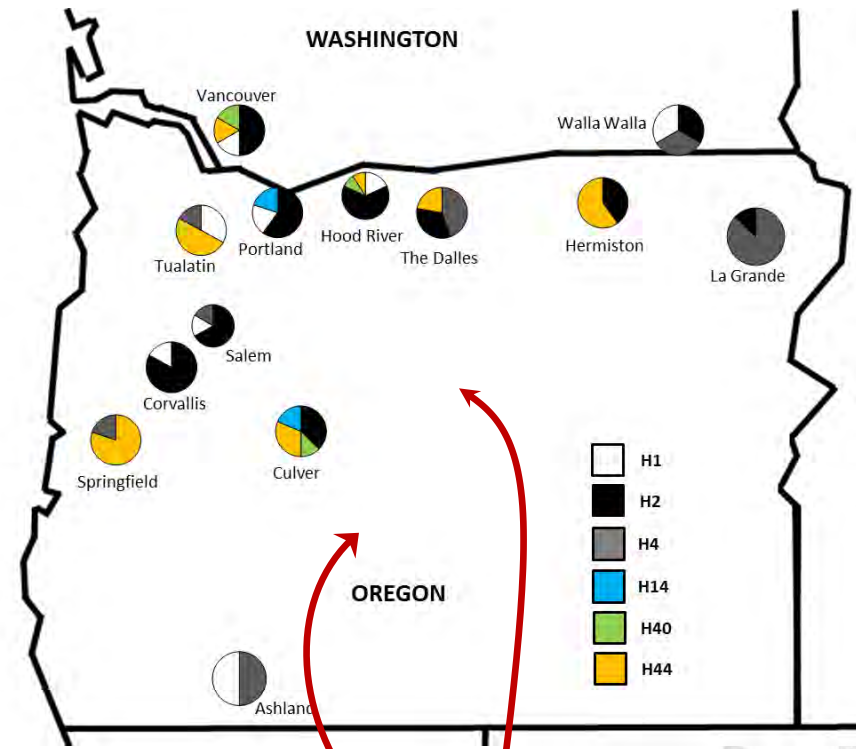

After Xu et al. 2013

Washington and Oregon

- 6 haplotypes recovered from 88 specimens
- Prevalence of H2 (39%) and to a less extent H44 (21%)



H44 is evidenced for the first time

H1, H2, H4 and H14

**Beijing and Nanjing areas in China:
the likely source regions for WA and OR**

But not only... Japan

**Historical interception from Japan in
British Columbia**

After Cariepy et al. 2014

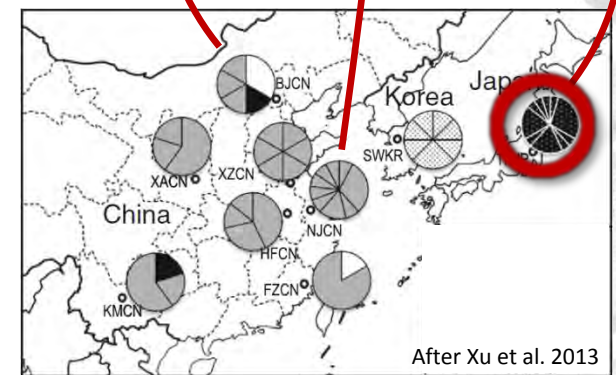
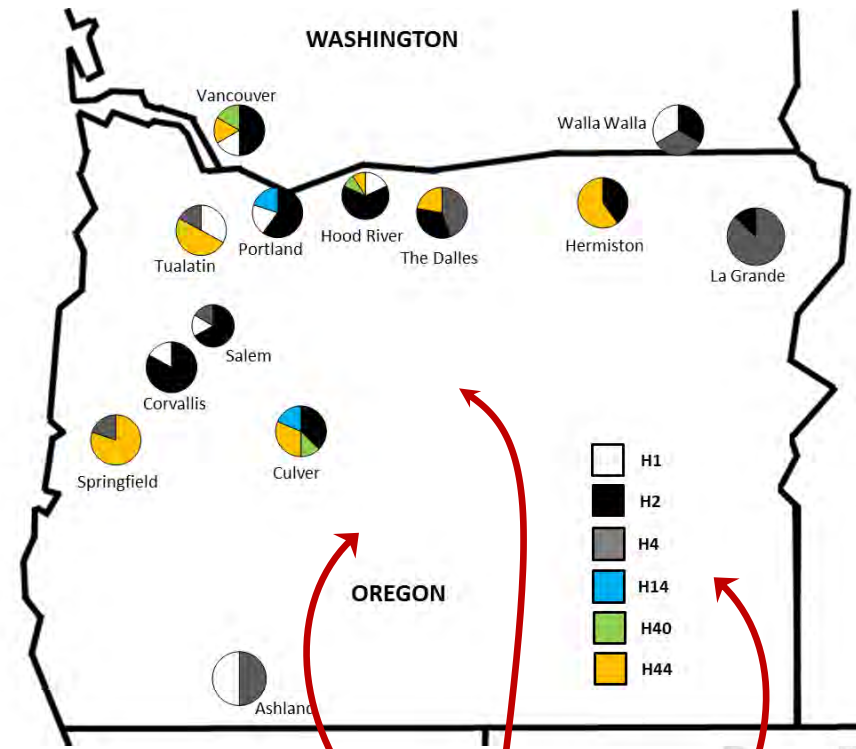

After Xu et al. 2013

Most likely scenario evidenced by the molecular data

- Invasion in Western US resulting from multiple sources in Asia



Most likely scenario evidenced by the molecular data

➤ Invasion in Western US resulting from multiple sources in Asia



Most likely scenario evidenced by the molecular data

➤ Invasion in Western US resulting from multiple sources in Asia



After Xu et al. 2013



Manuscript in preparation

Update on the genetic characterization of West Coast populations
of *Halyomorpha halys*
and adventive populations of its egg parasitoid *Trissolcus japonicus*

● Phylogeography of *Halyomorpha halys* in the U.S.

● Genetic diversity of *Trissolcus japonicus*

● Phylogeny of the Asian *Trissolcus*

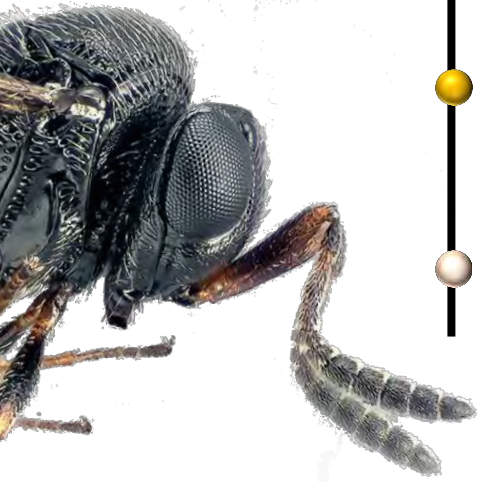

JHR 33: 113–117 (2013)
doi: 10.3897/JHR.33.5627
www.penssoft.net/journals/jhr

RESEARCH ARTICLE



JOURNAL OF
Hymenoptera
RESEARCH

New synonymy of *Trissolcus halyomorphae* Yang

Elijah J. Talamas¹, Matthew Buffington¹, Kim Hoelmer²



Talamas et al. 2015

- Specialist egg parasitoid of BMSB
 - Different strains from China, Japan and South Korea in culture
- Evaluation of its host range and efficacy



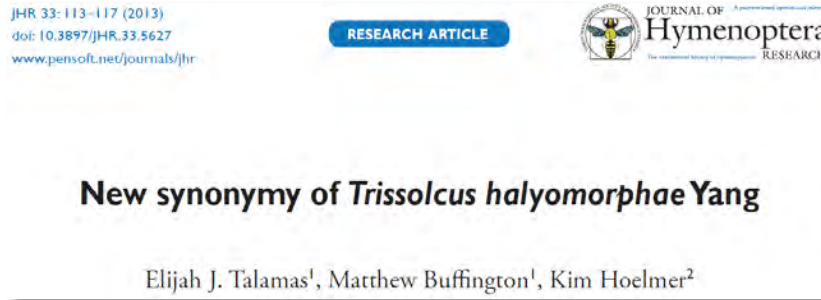

Talamas et al. 2015

- Specialist egg parasitoid of BMSB
 - Different strains from China, Japan and South Korea in culture
- Evaluation of its host range and efficacy

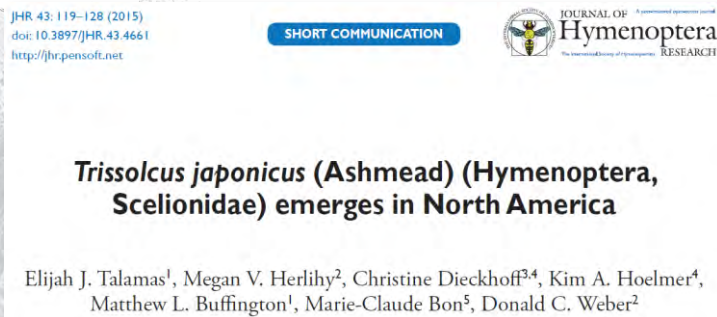

A survey conducted in 2014 revealed that *T. japonicus* was already present in the wild

- **How did *Trissolcus japonicus* come to this site?**
- **Accidental quarantine escape?**

Comparison of the genetic diversity



« Recovered population »

Quarantine colonies



Comparison of the genetic diversity



« Recovered population »

Quarantine colonies

Development of microsatellites

Population genetics requires successful development of microsatellites

→ These tools have been developed at the onset of the BMSB project

24 microsatellites

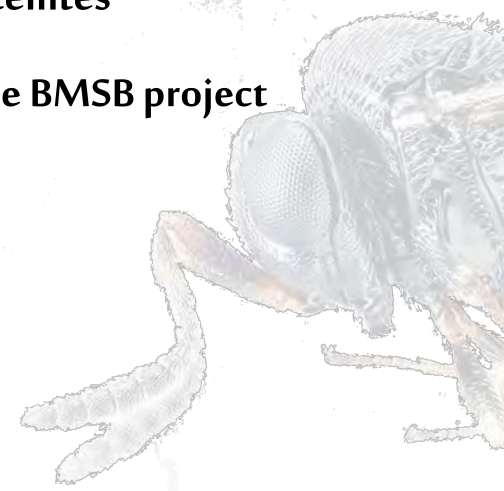

Genetic characterization of BMSB and its egg parasitoid

1. North American BMSB

2. North American *Trissolcus*

3. Phylogeny of *Trissolcus*

Sentinel egg masses



67 individuals

- 2014 $n = 38$
- 2015 $n = 29$

East Coast Survey

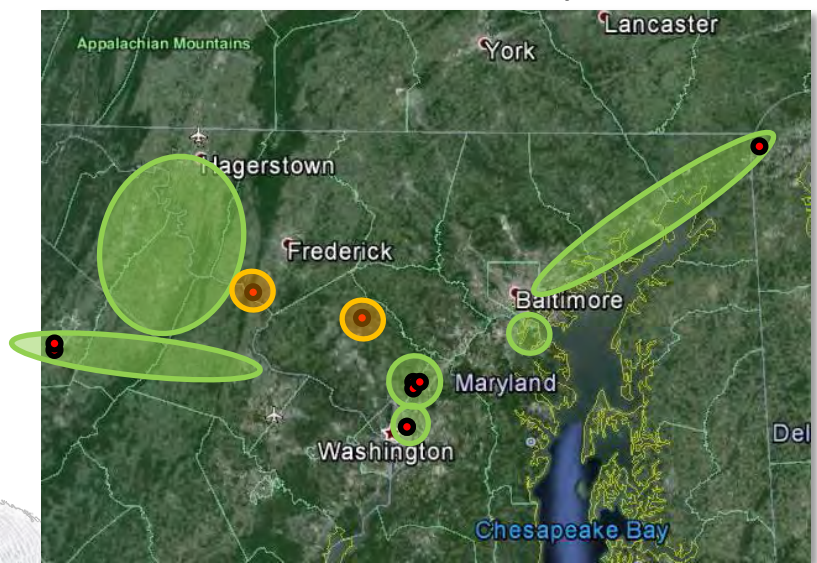

West Coast Survey

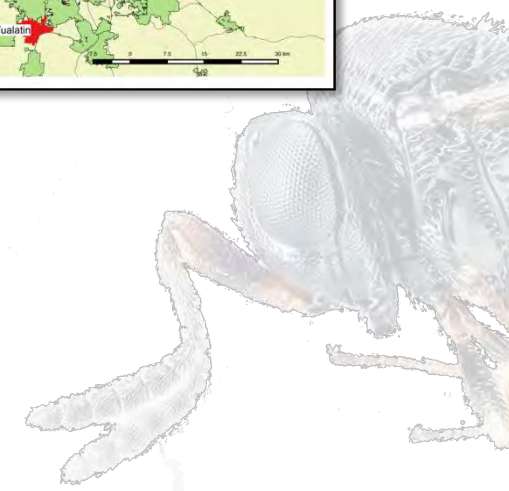
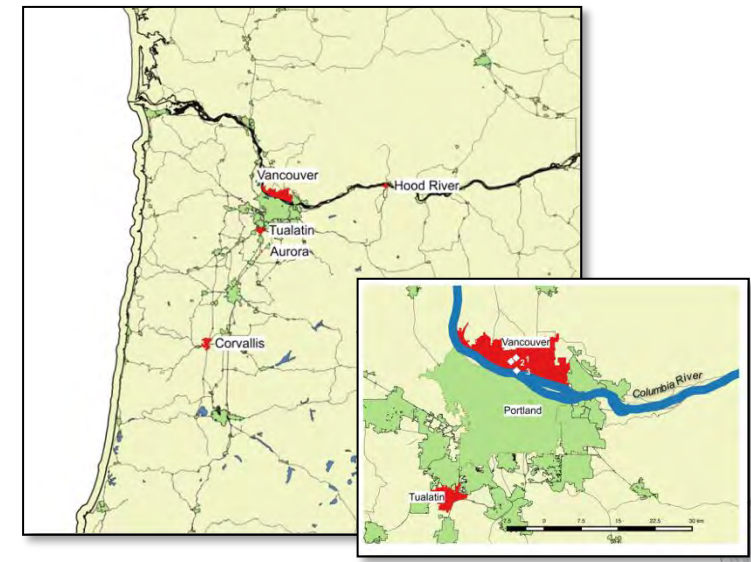

Genetic characterization of BMSB and its egg parasitoid

1. North American BMSB

2. North American *Trissolcus*

3. Phylogeny of *Trissolcus*

Sentinel egg masses



67 individuals

• 2014 *n* = 38

• 2015 *n* = 29

East Coast Survey

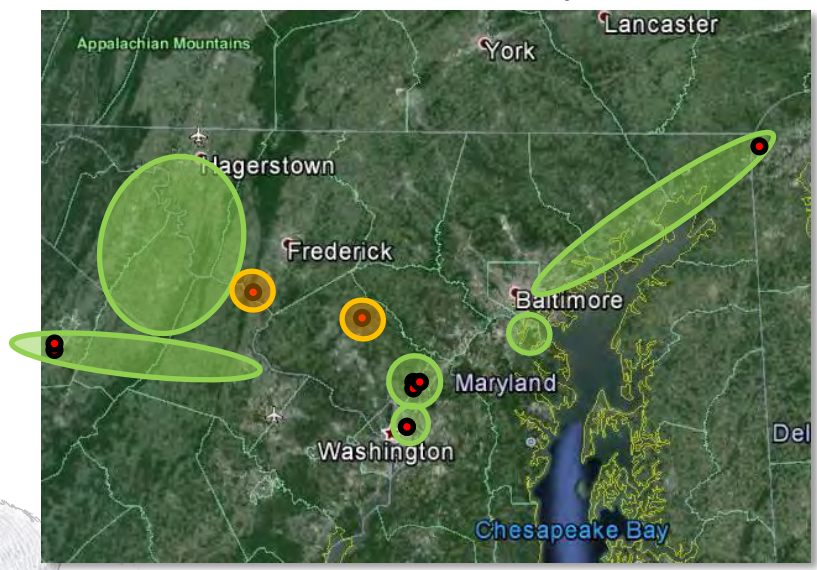

West Coast Survey

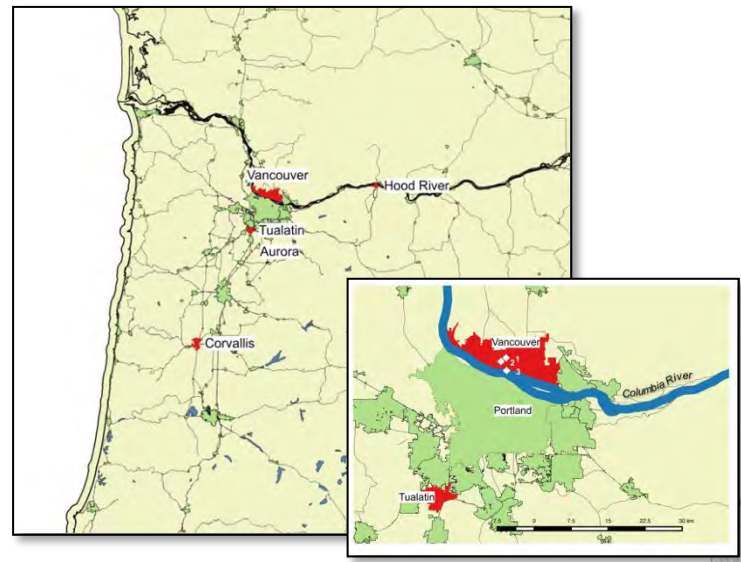

- Taxonomy
- Multilocus genotyping approach (24 microsatellites)
- Barcode sequencing (COI)



Wild specimens can be identified

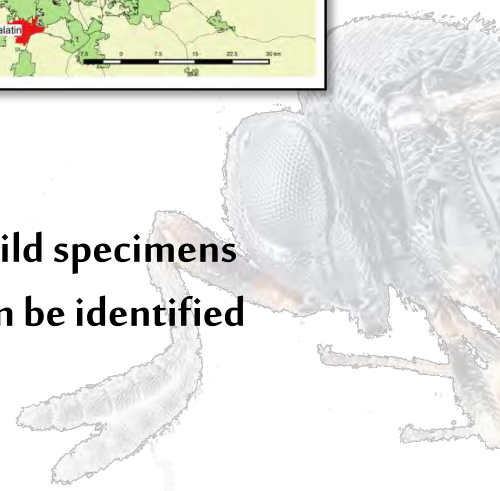
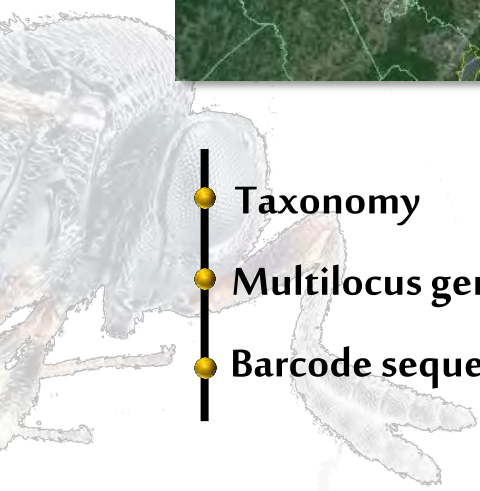

Genetic characterization of BMSB and its egg parasitoid

1. North American BMSB

2. North American *Trissolcus*

3. Phylogeny of *Trissolcus*

Genus	Species		EBCL id	Sex	Cuid	Label1
<i>Trissolcus</i>	<i>euschistii</i>	fragment	Tj221	?	destructive method	dissected from wild <i>Euschistus</i> EM#O-15-15
<i>Trissolcus</i>	<i>japonicus</i>	diss out	Tj222	f?	destructive method	BIIR sentinel ex Thyanta on Ash#NS-13-15
<i>Trissolcus</i>	<i>japonicus</i>		Tj223	m	destructive method	BIIR ex P. mac sentinel EM on ash tree August 2015 possible sentinel lab contaminant
<i>Trissolcus</i>	<i>japonicus</i>		Tj224	m	destructive method	BIIR ex P. mac sentinel EM on ash tree August 2015 possible sentinel lab contaminant
<i>Trissolcus</i>	<i>japonicus</i>		Tj225	m	destructive method	BIIR ex P. mac sentinel EM on ash tree August 2015 possible sentinel lab contaminant
<i>Trissolcus</i>	<i>japonicus</i>		Tj226	m	destructive method	BIIR ex P. mac sentinel EM on ash tree August 2015 possible sentinel lab contaminant
<i>Trissolcus</i>	<i>japonicus</i>		Tj227	m	destructive method	BIIR ex P. mac sentinel EM on ash tree August 2015 possible sentinel lab contaminant
<i>Trissolcus</i>	<i>japonicus</i>		Tj228	m	destructive method	BIIR ex P. mac sentinel EM on ash tree August 2015 possible sentinel lab contaminant
<i>Trissolcus</i>	<i>japonicus</i>		Tj229	m	destructive method	BIIR ex P. mac sentinel EM on ash tree August 2015 possible sentinel lab contaminant
<i>Trissolcus</i>	<i>japonicus</i>	partial	Tj230	?	destructive method	WC 17 83 BARC. M. Herlihy
<i>Trissolcus</i>	<i>japonicus</i>	partial	Tj231	?	destructive method	WC 11810 BARC. M. Herlihy
<i>Trissolcus</i>	<i>japonicus</i>	partial	Tj232	?	destructive method	DE? 7 83 BARC. M. Herlihy
<i>Trissolcus</i>	<i>japonicus</i>	partial	Tj233	?	destructive method	WC10 720 BARC. M. Herlihy
<i>Trissolcus</i>	<i>japonicus</i>	partial	Tj234	?	destructive method	WC11 (1) 8 BARC. M. Herlihy
<i>Trissolcus</i>	<i>japonicus</i>	partial	Tj235	?	destructive method	WC 3831
<i>Trissolcus</i>	<i>japonicus</i>	partial	Tj236	?	destructive method	OE283
<i>Trissolcus</i>	<i>japonicus</i>	partial	Tj237	?	destructive method	ON5817
<i>Trissolcus</i>	<i>japonicus</i>	partial	Tj238	?	destructive method	WC10810
<i>Trissolcus</i>	<i>japonicus</i>		Tj239	f	non invasive method	WC10727 BARC. M. Herlihy
<i>Trissolcus</i>	<i>japonicus</i>		Tj240	f	non invasive method	OES720 BARC. M. Herlihy
<i>Trissolcus</i>	<i>japonicus</i>		Tj241	f	non invasive method	WC 9810 BARC. M. Herlihy
<i>Trissolcus</i>	<i>japonicus</i>		Tj242	f	non invasive method	WC 18831
<i>Trissolcus</i>	<i>japonicus</i>		Tj243	f	non invasive method	WC 12831
<i>Trissolcus</i>	<i>japonicus</i>		Tj244	f	non invasive method	WC 11831
<i>Trissolcus</i>	<i>japonicus</i>		Tj245	f	non invasive method	WC 4831
<i>Trissolcus</i>	<i>japonicus</i>		Tj246	f	non invasive method	ON 8817
<i>Trissolcus</i>	<i>japonicus</i>		Tj247	m	non invasive method	BARC 15 Aug 2015
<i>Trissolcus</i>	<i>japonicus</i>		Tj248	m	non invasive method	BARC 15 Aug 2015
<i>Trissolcus</i>	sp closely related		Tj249	f	non invasive method	BARC 15 Aug 2015
<i>Trissolcus</i>	sp closely related		Tj250	f	non invasive method	BARC 15 Aug 2015
<i>Trissolcus</i>	<i>japonicus</i>		Tj251	f	non invasive method	BARC EM#6, 17 June 2015
<i>Trissolcus</i>	<i>japonicus</i>		Tj252	f	non invasive method	BARC EM#6, 17 June 2015
<i>Trissolcus</i>	<i>japonicus</i>		Tj253	f	non invasive method	BARC EM#6, 17 June 2015
<i>Trissolcus</i>	<i>japonicus</i>		Tj254	f	non invasive method	BARC EM#6, 17 June 2015
<i>Trissolcus</i>	<i>japonicus</i>		Tj255	f	non invasive method	BARC EM#6, 17 June 2015
<i>Trissolcus</i>	<i>japonicus</i>		Tj256	f	non invasive method	BARC EM#6, 17 June 2015
<i>Trissolcus</i>	<i>japonicus</i>		Tj257	m	non invasive method	BARC 18 Aug 2015
<i>Trissolcus</i>	<i>japonicus</i>		Tj258	m	non invasive method	BARC 18 Aug 2015
<i>Trissolcus</i>	<i>japonicus</i>		Tj259	m	non invasive method	BARC 18 Aug 2015
<i>Trissolcus</i>	<i>japonicus</i>		Tj260	m	non invasive method	BARC 18 Aug 2015



● Prevalence of *T. japonicus* in the populations recovered

Genus	Species		EBCL id	Sex	Cuid	Label1
Trissolcus	euschistii	fragment	Tj221	?	destructive method	dissected from wild Euschistus EM#O-15-15
Trissolcus	japonicus	diss out	Tj222	f?	destructive method	BIIR sentinel ex Thyanta on Ash#NS-13-15
Trissolcus	japonicus		Tj223	m	destructive method	BIIR ex P. mac sentinel EM on ash tree August 2015 possible sentinel lab contaminant
Trissolcus	japonicus		Tj224	m	destructive method	BIIR ex P. mac sentinel EM on ash tree August 2015 possible sentinel lab contaminant
Trissolcus	japonicus		Tj225	m	destructive method	BIIR ex P. mac sentinel EM on ash tree August 2015 possible sentinel lab contaminant
Trissolcus	japonicus		Tj226	m	destructive method	BIIR ex P. mac sentinel EM on ash tree August 2015 possible sentinel lab contaminant
Trissolcus	japonicus		Tj227	m	destructive method	BIIR ex P. mac sentinel EM on ash tree August 2015 possible sentinel lab contaminant
Trissolcus	japonicus		Tj228	m	destructive method	BIIR ex P. mac sentinel EM on ash tree August 2015 possible sentinel lab contaminant
Trissolcus	japonicus		Tj229	m	destructive method	BIIR ex P. mac sentinel EM on ash tree August 2015 possible sentinel lab contaminant
Trissolcus	japonicus	partial	Tj230	?	destructive method	WC 17 83 BARC. M. Herlihy
Trissolcus	japonicus	partial	Tj231	?	destructive method	WC 11810 BARC. M. Herlihy
Trissolcus	japonicus	partial	Tj232	?	destructive method	DE? 7 83 BARC. M. Herlihy
Trissolcus	japonicus	partial	Tj233	?	destructive method	WC10 720 BARC. M. Herlihy
Trissolcus	japonicus	partial	Tj234	?	destructive method	WC11 (1) 8 BARC. M. Herlihy
Trissolcus	japonicus	partial	Tj235	?	destructive method	WC 3831
Trissolcus	japonicus	partial	Tj236	?	destructive method	OE283
Trissolcus	japonicus	partial	Tj237	?	destructive method	ON5817
Trissolcus	japonicus	partial	Tj238	?	destructive method	WC10810
Trissolcus	japonicus		Tj239	f	non invasive method	WC10727 BARC. M. Herlihy
Trissolcus	japonicus		Tj240	f	non invasive method	OES720 BARC. M. Herlihy
Trissolcus	japonicus		Tj241	f	non invasive method	WC 9810 BARC. M. Herlihy
Trissolcus	japonicus		Tj242	f	non invasive method	WC 18831
Trissolcus	japonicus		Tj243	f	non invasive method	WC 12831
Trissolcus	japonicus		Tj244	f	non invasive method	WC 11831
Trissolcus	japonicus		Tj245	f	non invasive method	WC 4831
Trissolcus	japonicus		Tj246	f	non invasive method	ON 8817
Trissolcus	japonicus		Tj247	m	non invasive method	BARC 15 Aug 2015
Trissolcus	japonicus		Tj248	m	non invasive method	BARC 15 Aug 2015
Trissolcus	sp closely related		Tj249	f	non invasive method	BARC 15 Aug 2015
Trissolcus	sp closely related		Tj250	f	non invasive method	BARC 15 Aug 2015
Trissolcus	japonicus		Tj251	f	non invasive method	BARC EM#6, 17 June 2015
Trissolcus	japonicus		Tj252	f	non invasive method	BARC EM#6, 17 June 2015
Trissolcus	japonicus		Tj253	f	non invasive method	BARC EM#6, 17 June 2015
Trissolcus	japonicus		Tj254	f	non invasive method	BARC EM#6, 17 June 2015
Trissolcus	japonicus		Tj255	f	non invasive method	BARC EM#6, 17 June 2015
Trissolcus	japonicus		Tj256	f	non invasive method	BARC EM#6, 17 June 2015
Trissolcus	japonicus		Tj257	m	non invasive method	BARC 18 Aug 2015
Trissolcus	japonicus		Tj258	m	non invasive method	BARC 18 Aug 2015
Trissolcus	japonicus		Tj259	m	non invasive method	BARC 18 Aug 2015
Trissolcus	japonicus		Tj260	m	non invasive method	BARC 18 Aug 2015

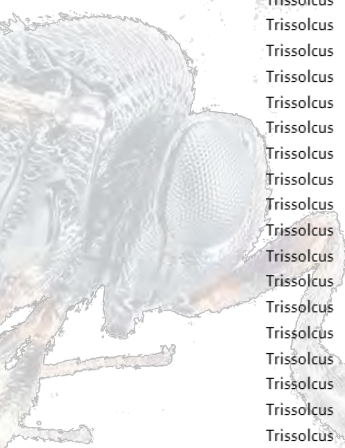

- Prevalence of *T. japonicus* in the populations recovered
- *Trissolcus euschitii* = North American species

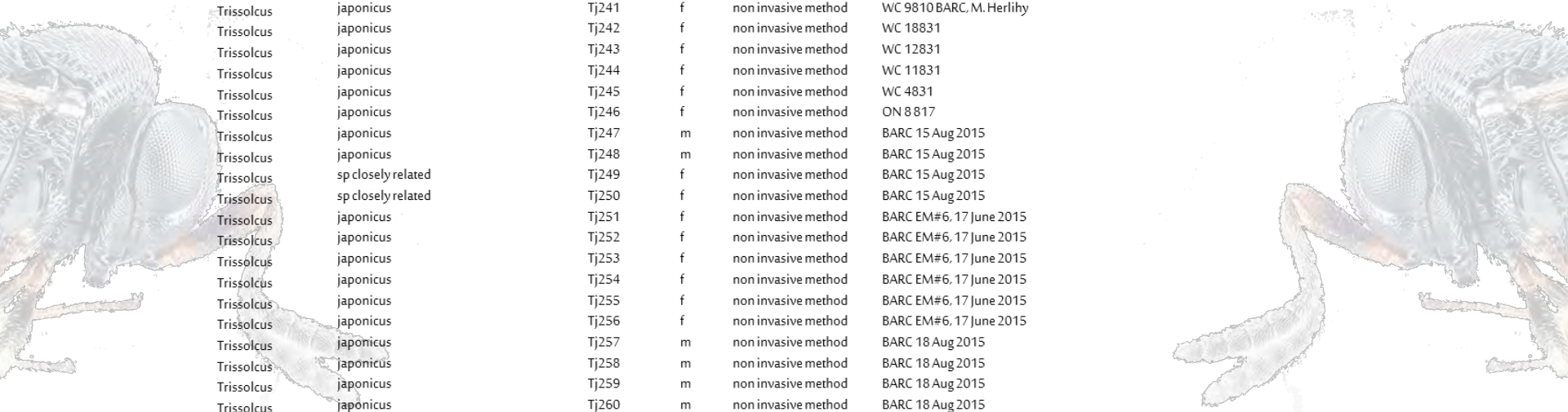

Genus	Species		EBCL id	Sex	Cuid	Label1
Trissolcus	euschitii	fragment	Tj221	?	destructive method	dissected from wild Euschistus EM#O-15-15
Trissolcus	japonicus	diss out	Tj222	?	destructive method	BIIR sentinel ex Thyanta on Ash#NS-13-15
Trissolcus	japonicus		Tj223	m	destructive method	BIIR ex P. mac sentinel EM on ash tree August 2015 possible sentinel lab contaminant
Trissolcus	japonicus		Tj224	m	destructive method	BIIR ex P. mac sentinel EM on ash tree August 2015 possible sentinel lab contaminant
Trissolcus	japonicus		Tj225	m	destructive method	BIIR ex P. mac sentinel EM on ash tree August 2015 possible sentinel lab contaminant
Trissolcus	japonicus		Tj226	m	destructive method	BIIR ex P. mac sentinel EM on ash tree August 2015 possible sentinel lab contaminant
Trissolcus	japonicus		Tj227	m	destructive method	BIIR ex P. mac sentinel EM on ash tree August 2015 possible sentinel lab contaminant
Trissolcus	japonicus		Tj228	m	destructive method	BIIR ex P. mac sentinel EM on ash tree August 2015 possible sentinel lab contaminant
Trissolcus	japonicus		Tj229	m	destructive method	BIIR ex P. mac sentinel EM on ash tree August 2015 possible sentinel lab contaminant
Trissolcus	japonicus	partial	Tj230	?	destructive method	WC 17 83 BARC. M. Herlihy
Trissolcus	japonicus	partial	Tj231	?	destructive method	WC 11810 BARC. M. Herlihy
Trissolcus	japonicus	partial	Tj232	?	destructive method	DE? 7 83 BARC. M. Herlihy
Trissolcus	japonicus	partial	Tj233	?	destructive method	WC10 720 BARC. M. Herlihy
Trissolcus	japonicus	partial	Tj234	?	destructive method	WC11 (1) 8 BARC. M. Herlihy
Trissolcus	japonicus	partial	Tj235	?	destructive method	WC 3831
Trissolcus	japonicus	partial	Tj236	?	destructive method	OE283
Trissolcus	japonicus	partial	Tj237	?	destructive method	ON5817
Trissolcus	japonicus	partial	Tj238	?	destructive method	WC10810
Trissolcus	japonicus		Tj239	f	non invasive method	WC10727 BARC. M. Herlihy
Trissolcus	japonicus		Tj240	f	non invasive method	OES720 BARC. M. Herlihy
Trissolcus	japonicus		Tj241	f	non invasive method	WC 9810 BARC. M. Herlihy
Trissolcus	japonicus		Tj242	f	non invasive method	WC 18831
Trissolcus	japonicus		Tj243	f	non invasive method	WC 12831
Trissolcus	japonicus		Tj244	f	non invasive method	WC 11831
Trissolcus	japonicus		Tj245	f	non invasive method	WC 4831
Trissolcus	japonicus		Tj246	f	non invasive method	ON 8817
Trissolcus	japonicus		Tj247	m	non invasive method	BARC 15 Aug 2015
Trissolcus	japonicus		Tj248	m	non invasive method	BARC 15 Aug 2015
Trissolcus	sp closely related		Tj249	f	non invasive method	BARC 15 Aug 2015
Trissolcus	sp closely related		Tj250	f	non invasive method	BARC 15 Aug 2015
Trissolcus	japonicus		Tj251	f	non invasive method	BARC EM#6, 17 June 2015
Trissolcus	japonicus		Tj252	f	non invasive method	BARC EM#6, 17 June 2015
Trissolcus	japonicus		Tj253	f	non invasive method	BARC EM#6, 17 June 2015
Trissolcus	japonicus		Tj254	f	non invasive method	BARC EM#6, 17 June 2015
Trissolcus	japonicus		Tj255	f	non invasive method	BARC EM#6, 17 June 2015
Trissolcus	japonicus		Tj256	f	non invasive method	BARC EM#6, 17 June 2015
Trissolcus	japonicus		Tj257	m	non invasive method	BARC 18 Aug 2015
Trissolcus	japonicus		Tj258	m	non invasive method	BARC 18 Aug 2015
Trissolcus	japonicus		Tj259	m	non invasive method	BARC 18 Aug 2015
Trissolcus	japonicus		Tj260	m	non invasive method	BARC 18 Aug 2015

- Prevalence of *T. japonicus* in the populations recovered
- *Trissolcus euschitii* = North American species

Genus	Species		EBCL id	Sex	Cuid	Label1
<i>Trissolcus</i>	<i>euschitii</i>	fragment	Tj221	?	destructive method	dissected from wild <i>Euschistus</i> EM#O-15-15
<i>Trissolcus</i>	<i>japonicus</i>	diss out	Tj222	?	destructive method	BIIR sentinel ex Thyanta on Ash#NS-13-15
<i>Trissolcus</i>	<i>japonicus</i>		Tj223	m	destructive method	BIIR ex P. mac sentinel EM on ash tree August 2015 possible sentinel lab contaminant
<i>Trissolcus</i>	<i>japonicus</i>		Tj224	m	destructive method	BIIR ex P. mac sentinel EM on ash tree August 2015 possible sentinel lab contaminant
<i>Trissolcus</i>	<i>japonicus</i>		Tj225	m	destructive method	BIIR ex P. mac sentinel EM on ash tree August 2015 possible sentinel lab contaminant
<i>Trissolcus</i>	<i>japonicus</i>		Tj226	m	destructive method	BIIR ex P. mac sentinel EM on ash tree August 2015 possible sentinel lab contaminant
<i>Trissolcus</i>	<i>japonicus</i>		Tj227	m	destructive method	BIIR ex P. mac sentinel EM on ash tree August 2015 possible sentinel lab contaminant
<i>Trissolcus</i>	<i>japonicus</i>		Tj228	m	destructive method	BIIR ex P. mac sentinel EM on ash tree August 2015 possible sentinel lab contaminant
<i>Trissolcus</i>	<i>japonicus</i>		Tj229	m	destructive method	BIIR ex P. mac sentinel EM on ash tree August 2015 possible sentinel lab contaminant
<i>Trissolcus</i>	<i>japonicus</i>	partial	Tj230	?	destructive method	WC 17 83 BARC. M. Herlihy
<i>Trissolcus</i>	<i>japonicus</i>	partial	Tj231	?	destructive method	WC 11810 BARC. M. Herlihy
<i>Trissolcus</i>	<i>japonicus</i>	partial	Tj232	?	destructive method	DE7 83 BARC. M. Herlihy
<i>Trissolcus</i>	<i>japonicus</i>	partial	Tj233	?	destructive method	WC10 720 BARC. M. Herlihy
<i>Trissolcus</i>	<i>japonicus</i>	partial	Tj234	?	destructive method	WC11 (1) 8 BARC. M. Herlihy
<i>Trissolcus</i>	<i>japonicus</i>	partial	Tj235	?	destructive method	WC 3831
<i>Trissolcus</i>	<i>japonicus</i>	partial	Tj236	?	destructive method	OE283
<i>Trissolcus</i>	<i>japonicus</i>	partial	Tj237	?	destructive method	ONS817
<i>Trissolcus</i>	<i>japonicus</i>	partial	Tj238	?	destructive method	WC10810
<i>Trissolcus</i>	<i>japonicus</i>		Tj239	f	non invasive method	WC10727 BARC. M. Herlihy
<i>Trissolcus</i>	<i>japonicus</i>		Tj240	f	non invasive method	OES720 BARC. M. Herlihy
<i>Trissolcus</i>	<i>japonicus</i>		Tj241	f	non invasive method	WC 9810 BARC. M. Herlihy
<i>Trissolcus</i>	<i>japonicus</i>		Tj242	f	non invasive method	WC 18831
<i>Trissolcus</i>	<i>japonicus</i>		Tj243	f	non invasive method	WC 12831
<i>Trissolcus</i>	<i>japonicus</i>		Tj244	f	non invasive method	WC 11831
<i>Trissolcus</i>	<i>japonicus</i>		Tj245	f	non invasive method	WC 4831
<i>Trissolcus</i>	<i>japonicus</i>		Tj246	f	non invasive method	ON 8817
<i>Trissolcus</i>	<i>japonicus</i>		Tj247	m	non invasive method	BARC 15 Aug 2015
<i>Trissolcus</i>	<i>japonicus</i>		Tj248	m	non invasive method	BARC 15 Aug 2015
<i>Trissolcus</i>	sp closely related		Tj249	f	non invasive method	BARC 15 Aug 2015
<i>Trissolcus</i>	sp closely related		Tj250	f	non invasive method	BARC 15 Aug 2015
<i>Trissolcus</i>	<i>japonicus</i>		Tj251	f	non invasive method	BARC EM#6, 17 June 2015
<i>Trissolcus</i>	<i>japonicus</i>		Tj252	f	non invasive method	BARC EM#6, 17 June 2015
<i>Trissolcus</i>	<i>japonicus</i>		Tj253	f	non invasive method	BARC EM#6, 17 June 2015
<i>Trissolcus</i>	<i>japonicus</i>		Tj254	f	non invasive method	BARC EM#6, 17 June 2015
<i>Trissolcus</i>	<i>japonicus</i>		Tj255	f	non invasive method	BARC EM#6, 17 June 2015
<i>Trissolcus</i>	<i>japonicus</i>		Tj256	f	non invasive method	BARC EM#6, 17 June 2015
<i>Trissolcus</i>	<i>japonicus</i>		Tj257	m	non invasive method	BARC 18 Aug 2015
<i>Trissolcus</i>	<i>japonicus</i>		Tj258	m	non invasive method	BARC 18 Aug 2015
<i>Trissolcus</i>	<i>japonicus</i>		Tj259	m	non invasive method	BARC 18 Aug 2015
<i>Trissolcus</i>	<i>japonicus</i>		Tj260	m	non invasive method	BARC 18 Aug 2015

● Evidence of a second lineage of egg parasitoid?

2 individuals

COI (barcode) results

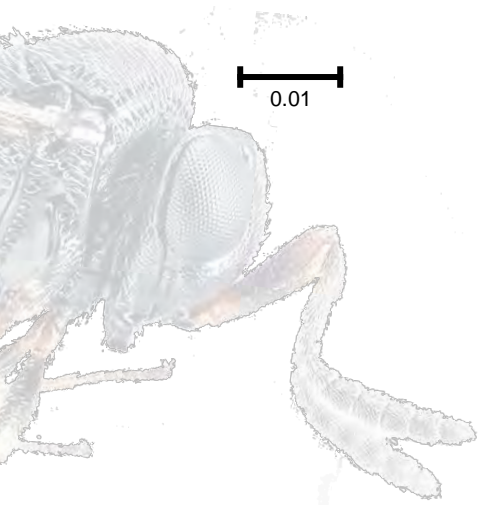
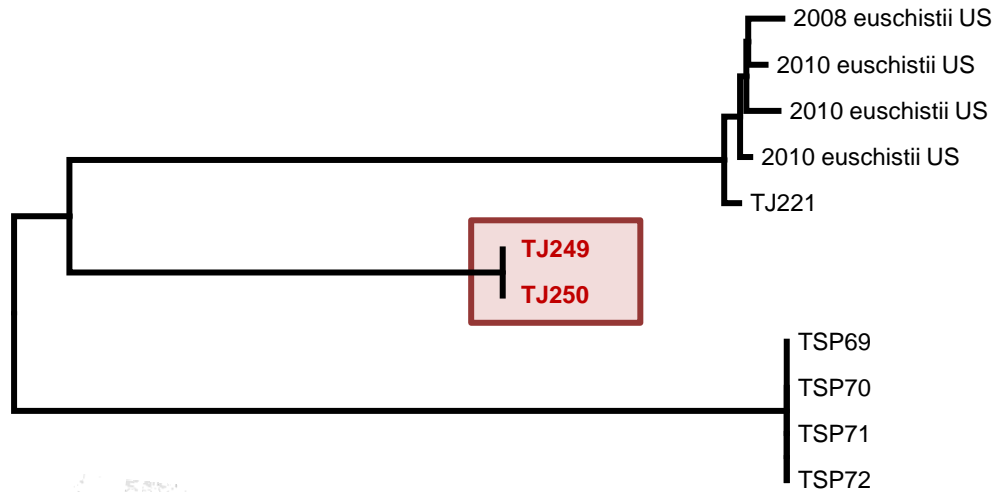

COI (barcode) results

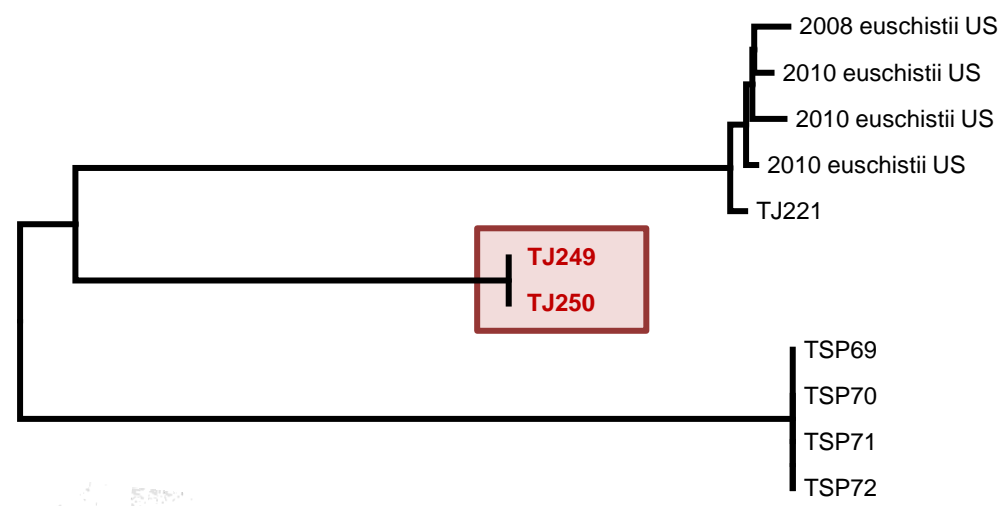

Trissolcus euschistii

Trissolcus sp.

Trissolcus corai

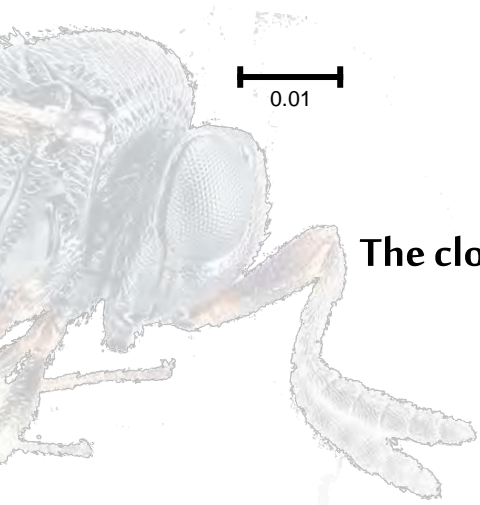

The closest taxa



Trissolcus euschistii

Trissolcus corai



COI (barcode) results

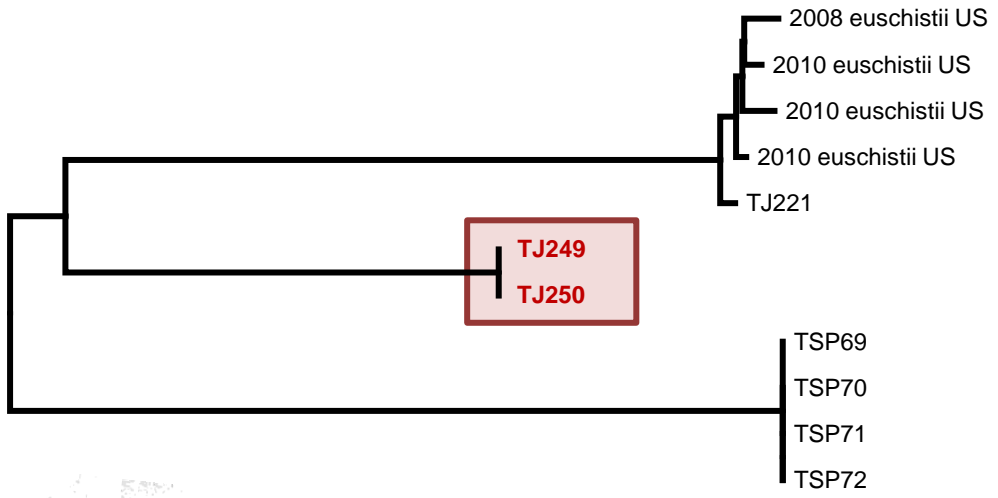

Trissolcus euschistii

↕ p distance = 11.5 %

Trissolcus sp.

↕ p distance = 12.6 %

Trissolcus corai

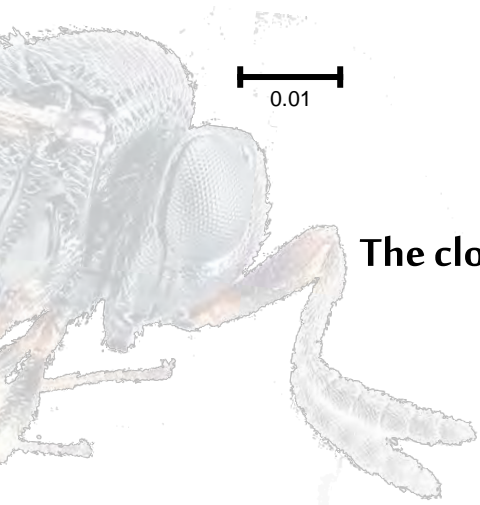

The closest taxa

↗ *Trissolcus euschistii*
↘ *Trissolcus corai*



Morphology
T. euschistii

More genes !

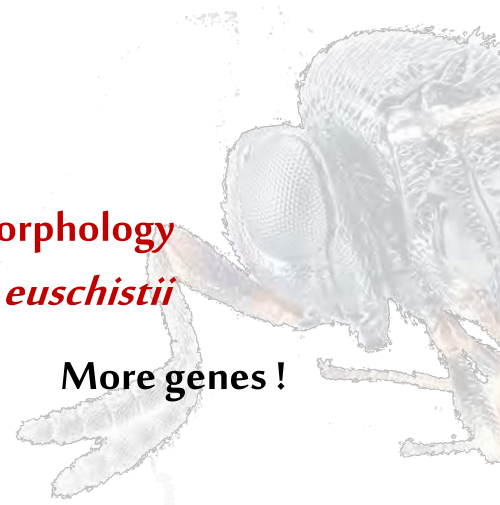

Bayesian clustering approach

Structure software



Bayesian clustering approach

Structure software

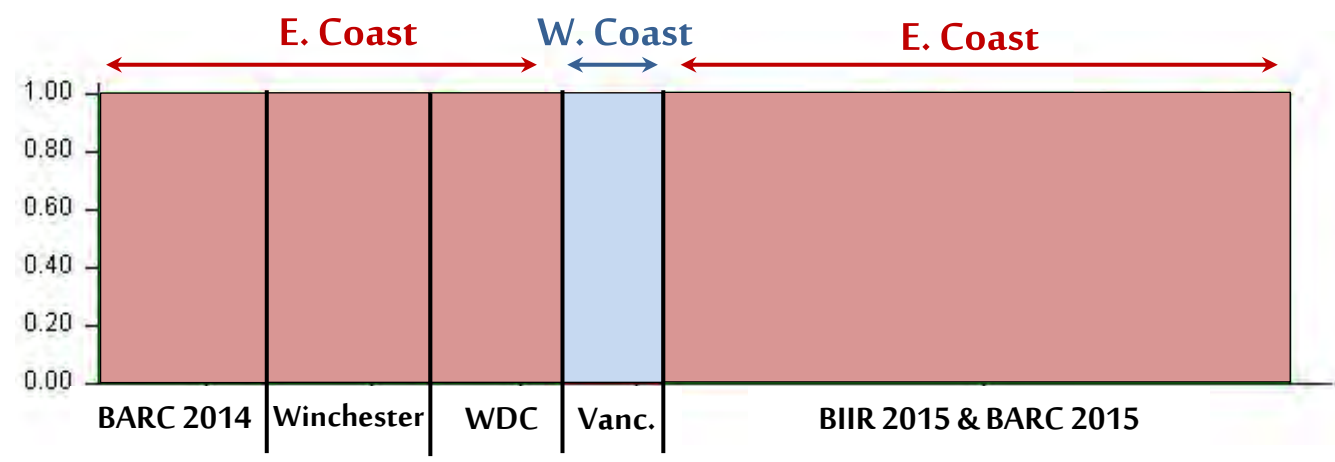

Bayesian clustering approach

Structure software

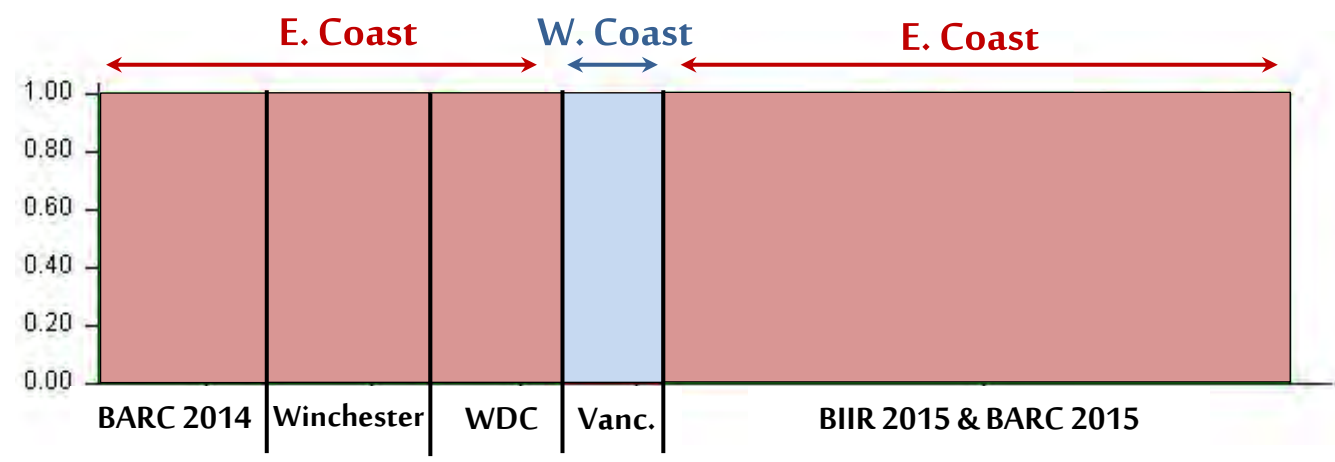

- The most likely value: $K = 2$
- Different clustering pattern → West Coast population *versus* East Coast populations

➤ Different sources for East Coast and West Coast populations ?

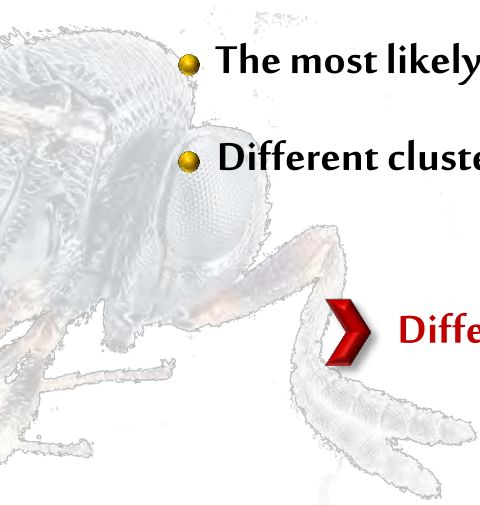

Principale Coordinate Analysis (PCoA)

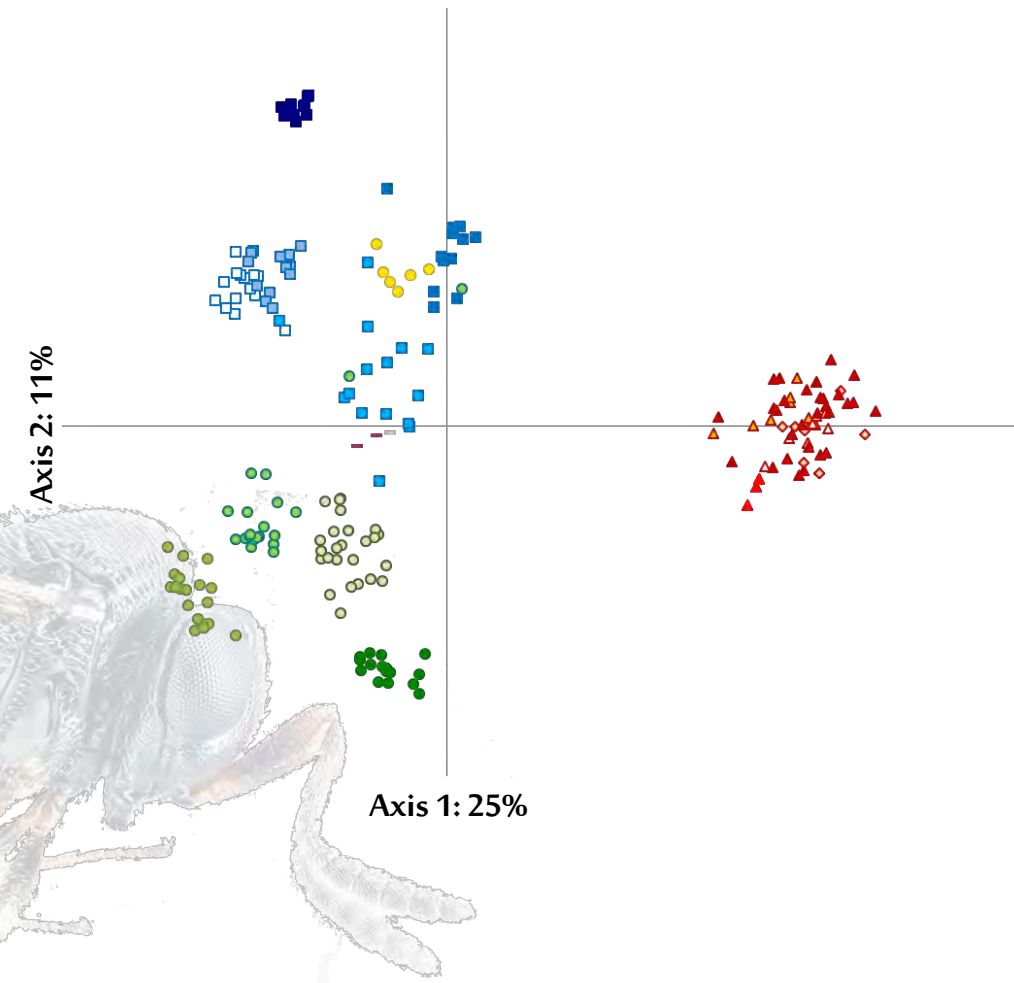

Principale Coordinate Analysis (PCoA)

- Axis 1: Split between East Coast populations and all other populations



Populations recovered in East Coast do not correspond to an accidental quarantine escape

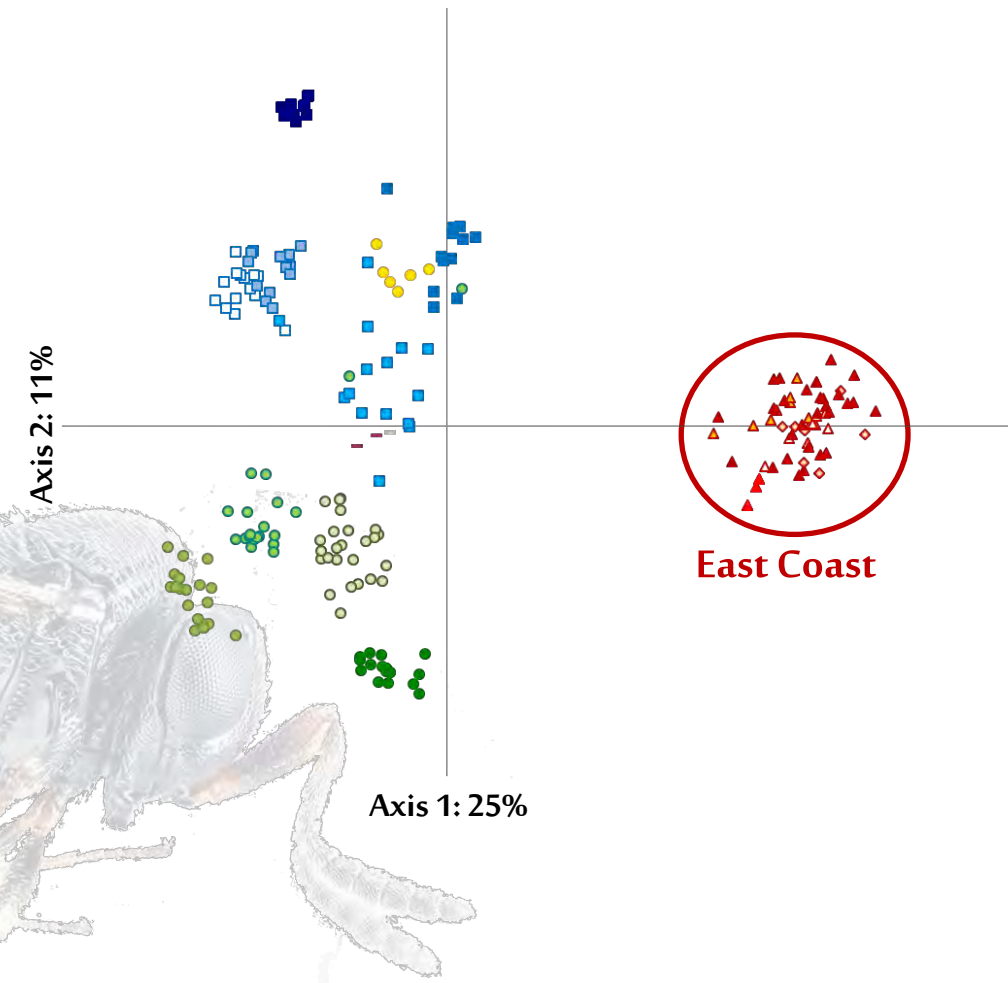

Principale Coordinate Analysis (PCoA)

- Axis 1: Split between East Coast populations and all other populations



Populations recovered in East Coast do not correspond to an accidental quarantine escape

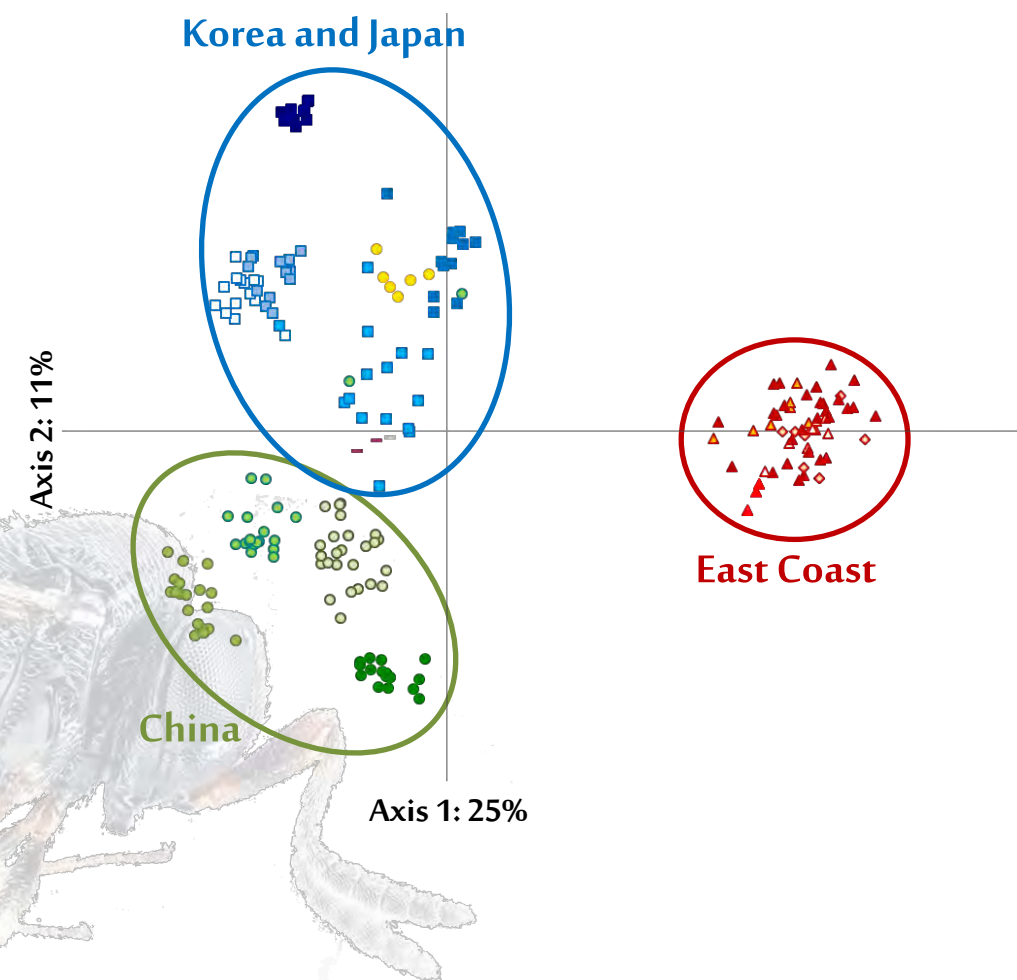

Principale Coordinate Analysis (PCoA)

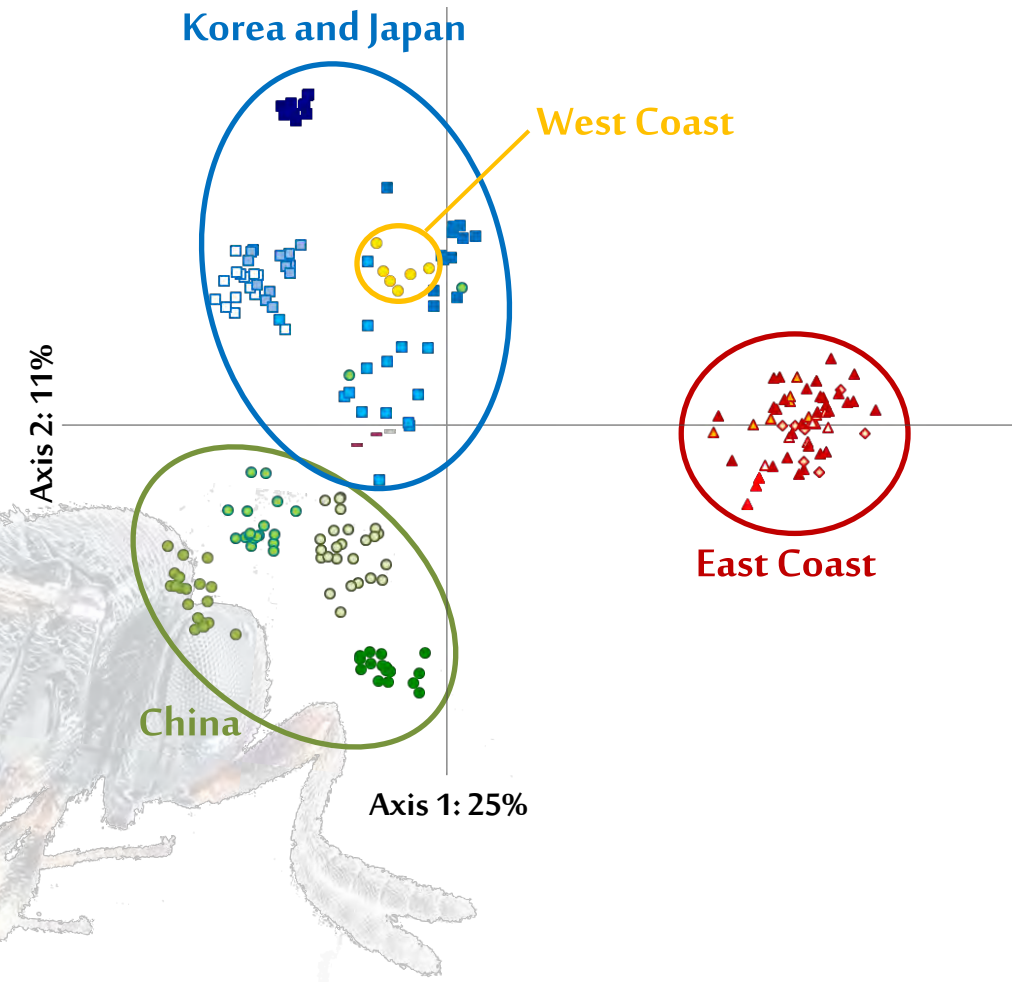

- Axis 1: Split between East Coast populations and all other populations



Populations recovered in East Coast do not correspond to an accidental quarantine escape

- West Coast individuals
→ Cluster with Korean group



No reason that those individuals correspond to an accidental quarantine escape

Korean origin following an introduction of parasitized eggs or hitchhiking adults

What's next?

- Manuscript in preparation



- A master degree student

→ To type all potential endosymbionts present in the quarantine colonies (using a multilocus approach)



Update on the genetic characterization of West Coast populations
of *Halyomorpha halys*
and adventive populations of its egg parasitoid *Trissolcus japonicus*



● Phylogeography of *Halyomorpha halis* in the U.S.

● Genetic diversity of *Trissolcus japonicus*

● Phylogeny of the Asian *Trissolcus*

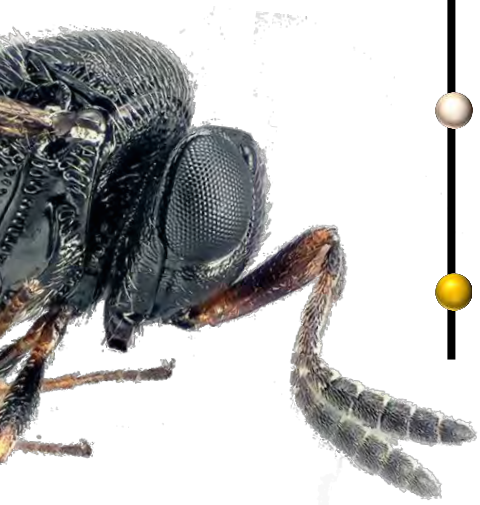

Genetic characterization of BMSB and its egg parasitoid

1. North American BMSB

2. North American Trissolcus

3. Phylogeny of Trissolcus

- Comprehensive Phylogenetic reconstruction based on concatenated analysis (1616bp) of mitochondrial and nuclear genes
- 289 individuals used

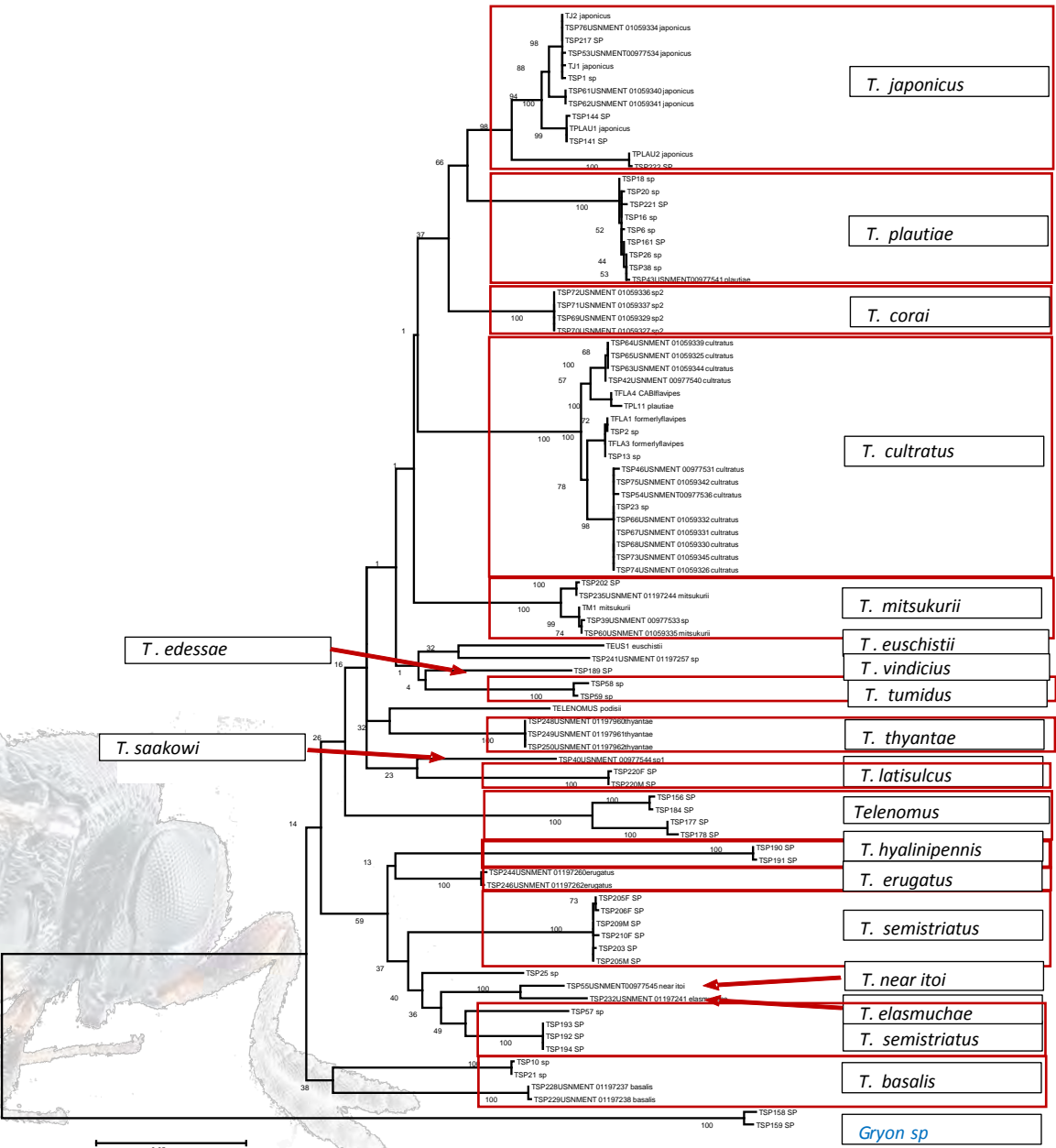

Genetic characterization of BMSB and its egg parasitoid

1. North American BMSB

2. North American Trissolcus

3. Phylogeny of Trissolcus

- Comprehensive Phylogenetic reconstruction based on concatenated analysis (1616bp) of mitochondrial and nuclear genes
- 289 individuals used



Congruence between molecular delineation and morphological characters for most lineages

Evidence of 19 *Trissolcus* species
Some are new to science

Real tool for diagnostic

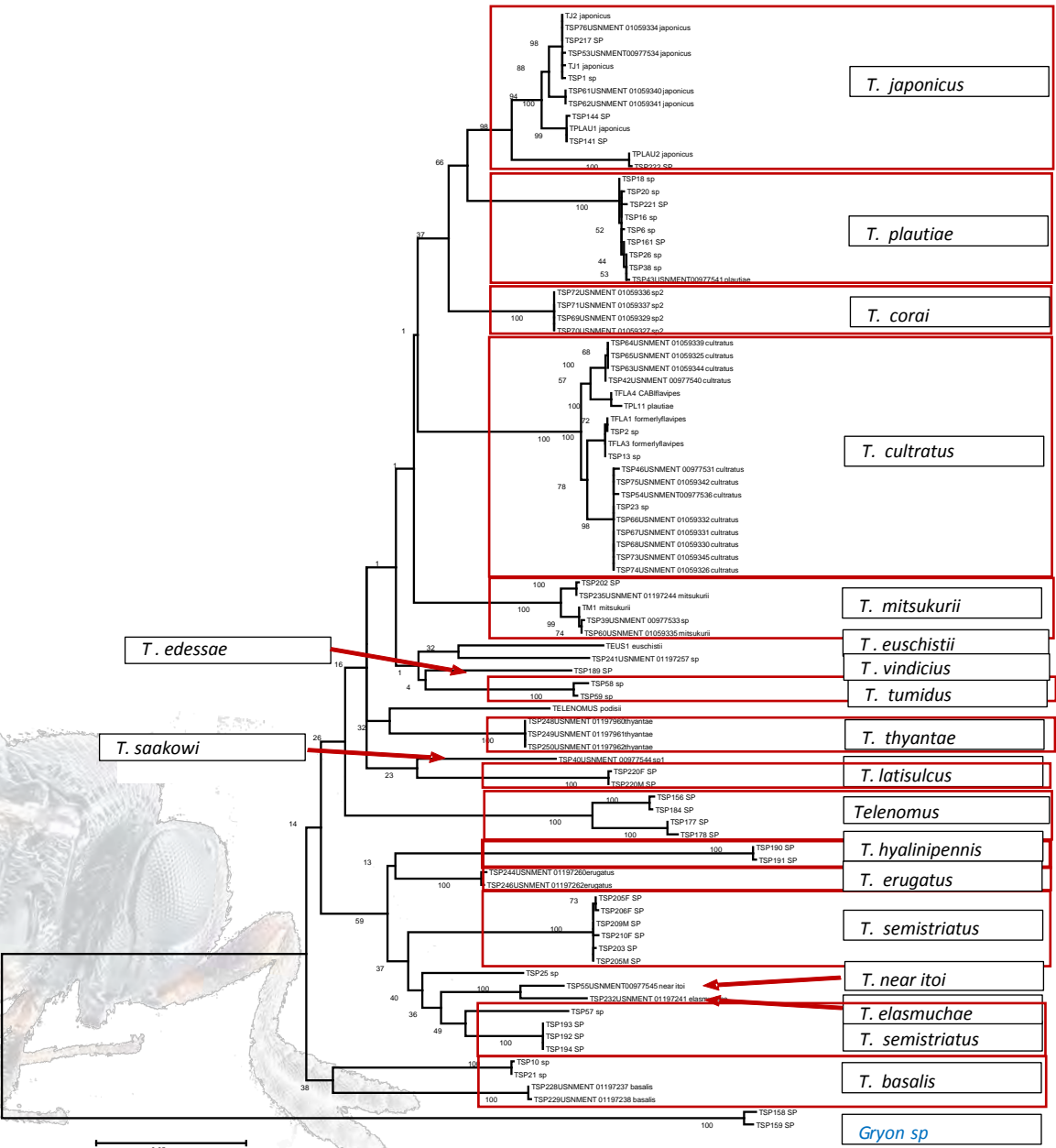

What's next?

- 2 more genes are sequenced to get a robust phylogeny
- Final results for datation are expected before ICE2016
- Preliminary results and the philosophy of the project



→ Poster and oral presentation of the project

Thank you for your attention...



Thank you for your attention...



COI (barcode) results

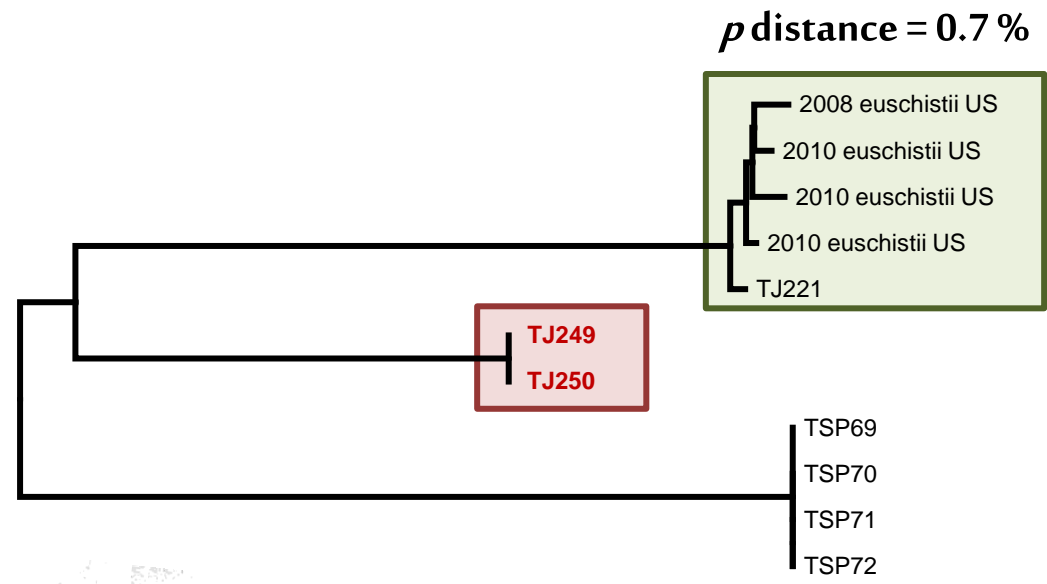

Trissolcus euschistii



p distance = 11.5 %

Trissolcus sp.



p distance = 12.6 %

Trissolcus corai

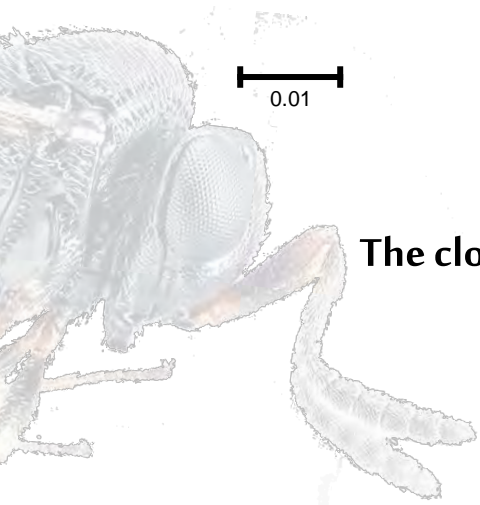

The closest taxa



Trissolcus euschistii

Trissolcus corai



New species ?

